

CONTENTS

Rue Sala Corded Single Pendant Assembly

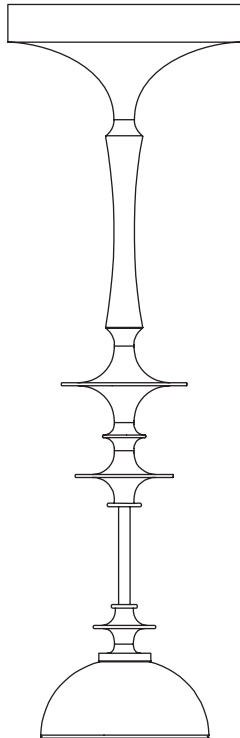

(x2) 8-32 J-box Screw



Glass

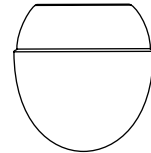

(x5) Wago Connector 2



2" Diffuser

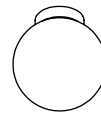

(x2) Toggle anchor
On 240V fixtures only

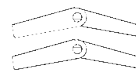

(x2) Wood screw
On 240V fixtures only



(x2) Long 8-32 screw
On 240V fixtures only

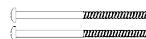

(x2) Metal screw
On 240V fixtures only

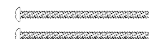

SAFETY INFORMATION

Suitable for dry, indoor use only.

Maximum ambient temperature: 25°C

The light source contained in this luminaire shall only be replaced by the manufacturer or his service agent or a similar qualified person.

RUE SALA CORDED SINGLE PENDANT | INSTALLATION

Note: Please contact a licensed electrician.

1. Unscrew two screws (A) from the fixture canopy (B), twist in clockwise direction to release the crossbar (C).
2. Bring the crossbar up to J-box (D), connect the ground wire with provided 2-port wago (E)
3. Pull the lead wires (F) through the center hole of crossbar, and secure the crossbar to J-box with the two provided screws (G)

1

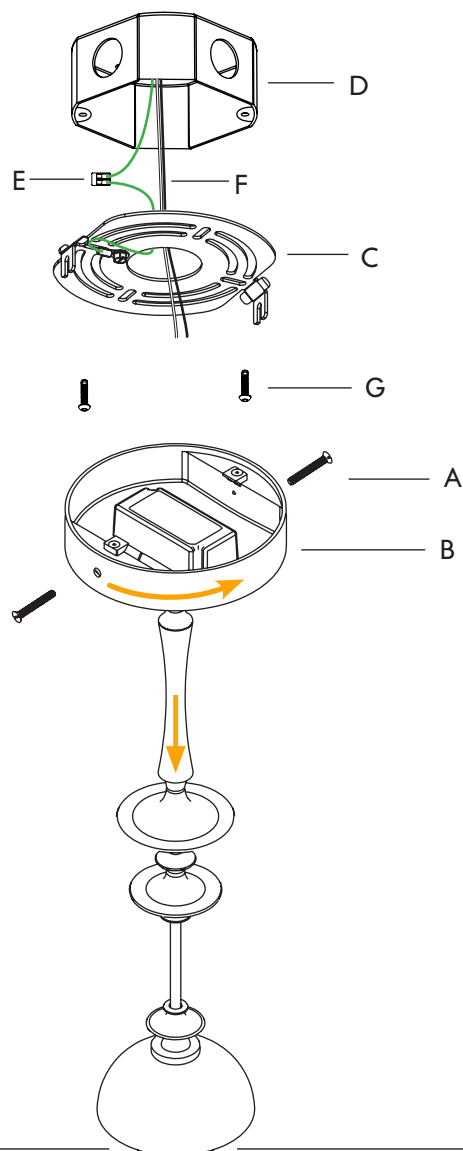

RUE SALA CORDED SINGLE PENDANT | INSTALLATION

Note: Please contact a licensed electrician.

4. Connect the lead wires with the provided 2-port wagos (H).
5. Optional: connect the dimming wires with the provided 2-port wagos (I).
6. Raise the fixture canopy (B) up to the crossbar, tuck in all the wires, and rotate it counter clockwise to set the canopy wedges on to the crossbar, and secure it with the two screw (A).

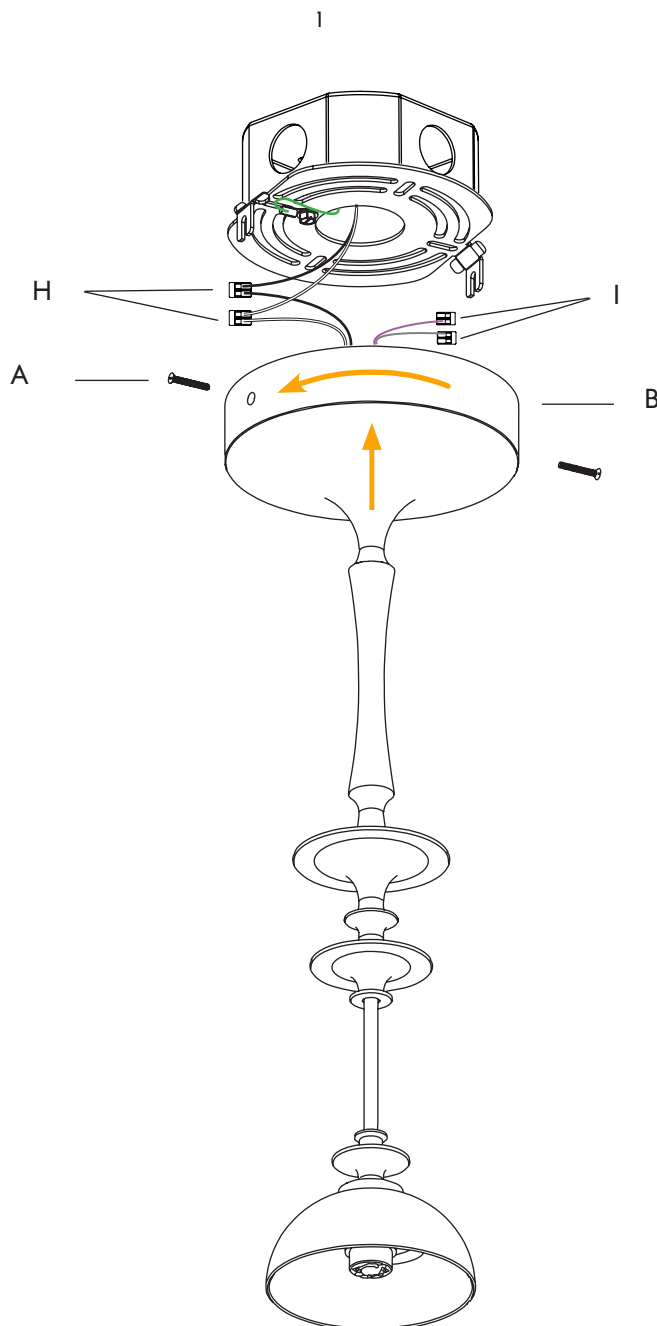

RUE SALA CORDED SINGLE PENDANT | INSTALLATION

Glass installation

1. Unscrew the threaded collar (A) to loosen the shade (B).
2. Screw on the 2" diffuser (C) onto the LED cup (D).
3. Raise the shade (B) and tilt it at a slight angle to give extra working space.
Next, fit the glass (E) at an angle over the 2" diffuser, rest the glass on the rubber pads (F).

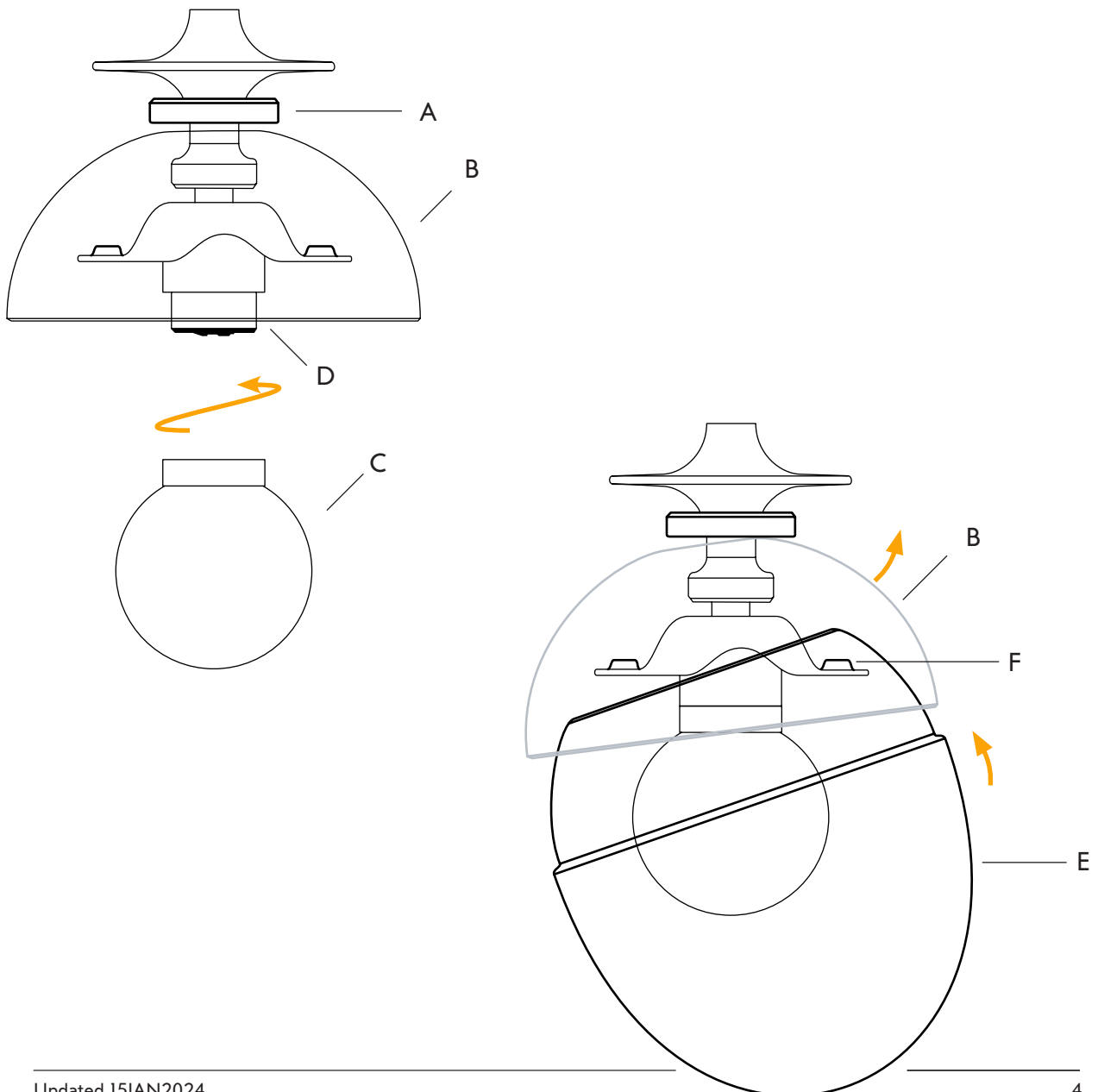

RUE SALA CORDED SINGLE PENDANT | INSTALLATION

Glass installation

4. Once the glass (E) is resting evenly on the rubber pads (F), lower the shade (B) over the glass, and secure it in place with a threaded collar (A).
5. Repeat glass installation as needed.

