

## CONTENTS

### Pearl Surface Mount

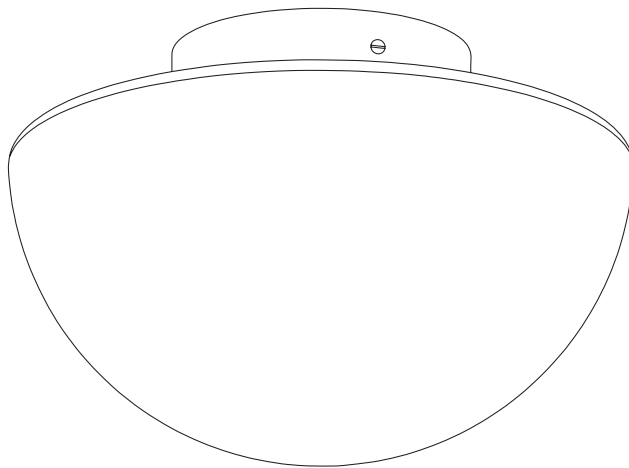

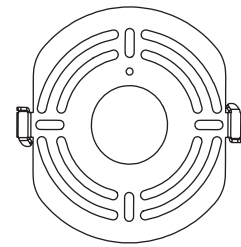





### Crossbar

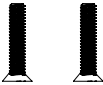
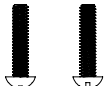

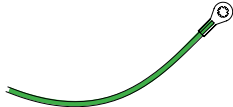
### (x7) Wago Connector

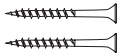

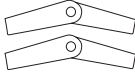
<p>(x2) Brass Screws</p> 	<p>(x2) #8-32 Screws</p> 	<p>Green Ground Screw</p> 	<p>Terminal Ring and Ground wire</p> 
<p>(x2) Metal screw (240V only)</p> 	<p>(x2) Wood screw (240V only)</p> 	<p>(x2) Long 8-32 screw (240V only)</p> 	<p>(x2) Toggle anchor (240V only)</p> 

## SAFETY INFORMATION

Only suitable for direct mounting on non-combustible surfaces.  
Under no circumstances can Pearl Surface Mount be mounted on normally flammable surfaces. Suitable for dry or damp, indoor use only.

## PEARL SURFACE MOUNT | INSTALLATION

---

*Note: Please contact a licensed electrician.*

01. Attach the crossbar (A) to the junction box (B) with provided screws (C)  
Be sure to feed the wires through the crossbar center opening.
02. Connect the ground wire to the crossbar with provided two port wago (D)

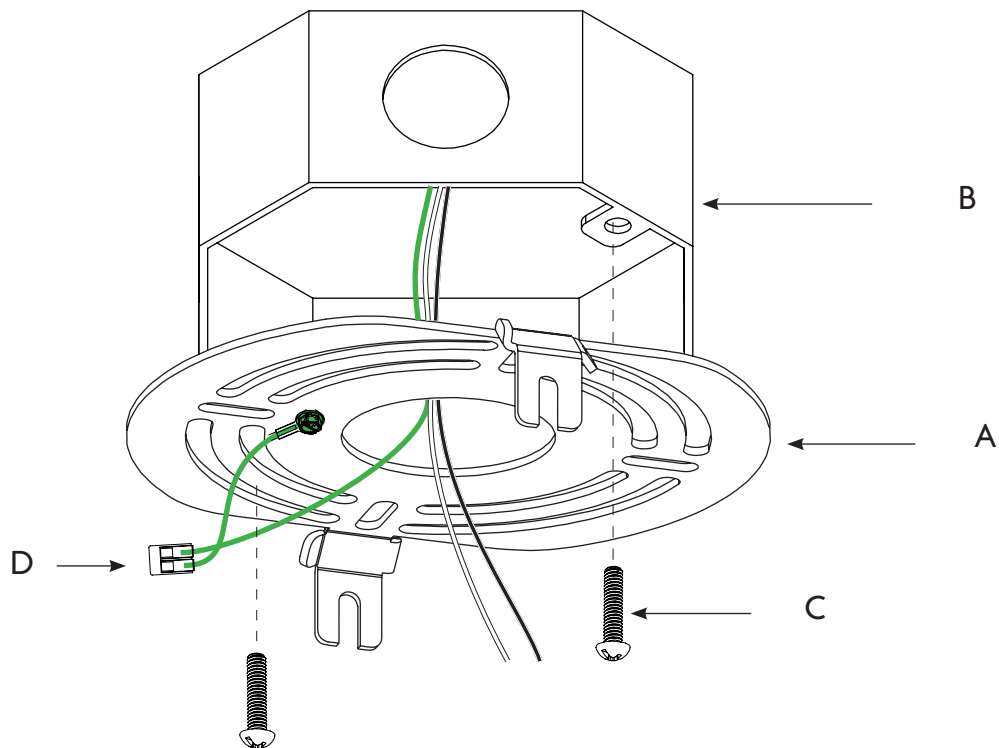

## PEARL SURFACE MOUNT | INSTALLATION

---

*Note: Please contact a licensed electrician.*

03. Lift the fixture (E) up to the crossbar (A), and connect the white and black wires with provided two port wagos (F).
04. Fit all wiring into the fixture canopy, then raise the fixture over the crossbar (A), be sure to align the canopy wedges with crossbar cleat (G) and twist counter clockwise to fit the wedges onto the crossbar cleats
05. Then secure the fixture with the provided two screws (H).

