

CONTENTS

Pole 04 Primary Mount with Crossbar (120v)
Pole 04 Primary Mount with Driver Box (240v)

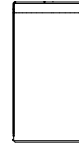

Unpowered Base



Pole Extrusion (see table) - One Labeled "Large Base"

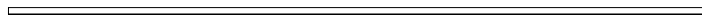

Pole Fitter (see table)

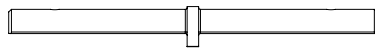

# of Sections	# of Extrusions	# of Fitters
3	3	2
4	4	3
5	5	4
6	6	5
7	7	6
8	8	7

Driver w/ Wagos (120v)

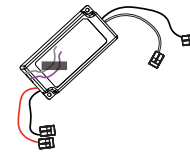

1x 7/64" Hex Driver

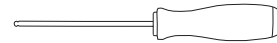

1x 5/64" Hex Driver



Sheet Metal
Screw
(4x) (240V)



Button Head Screw
(4x) (240v)



Wood Screw
(4x) (240v)



Toggle Anchors
(4x) (240v)



J-Box Screws (x2)



SAFETY INFORMATION

Only suitable for direct mounting on non-combustible surfaces.
Under no circumstances can Pole fixtures be mounted on normally flammable surfaces.
Suitable for dry, indoor use only.
Maximum ambient temperatures: 25° C

POLEL04 | INSTALLATION

Note: Please contact a licensed electrician for installation.

Note: Ensure power is off during installation.

1. Connect the high voltage wires from the driver to the lead wires from the Jbox and store the driver (A) inside the junction box. For 240V fixtures, the driver will be stored within an enclosed driver box. A hole must be made in the wall to accommodate this.

2. Connect the ground lead (B) from the crossbar (C) to the building's ground line. For 240v fixtures, connect the ground lead from the driver box to the building's ground line.

3. Pull the low voltage wires from the driver (D) through the center hole of the crossbar. Mount the crossbar to the junction box using provided #8-32 j-box screws (E).

For 240V fixtures, mount the crossbar to the wall using the appropriate anchor hardware.

Note: Make sure to mount the crossbar with the tabs parallel to the direction of the fixture.

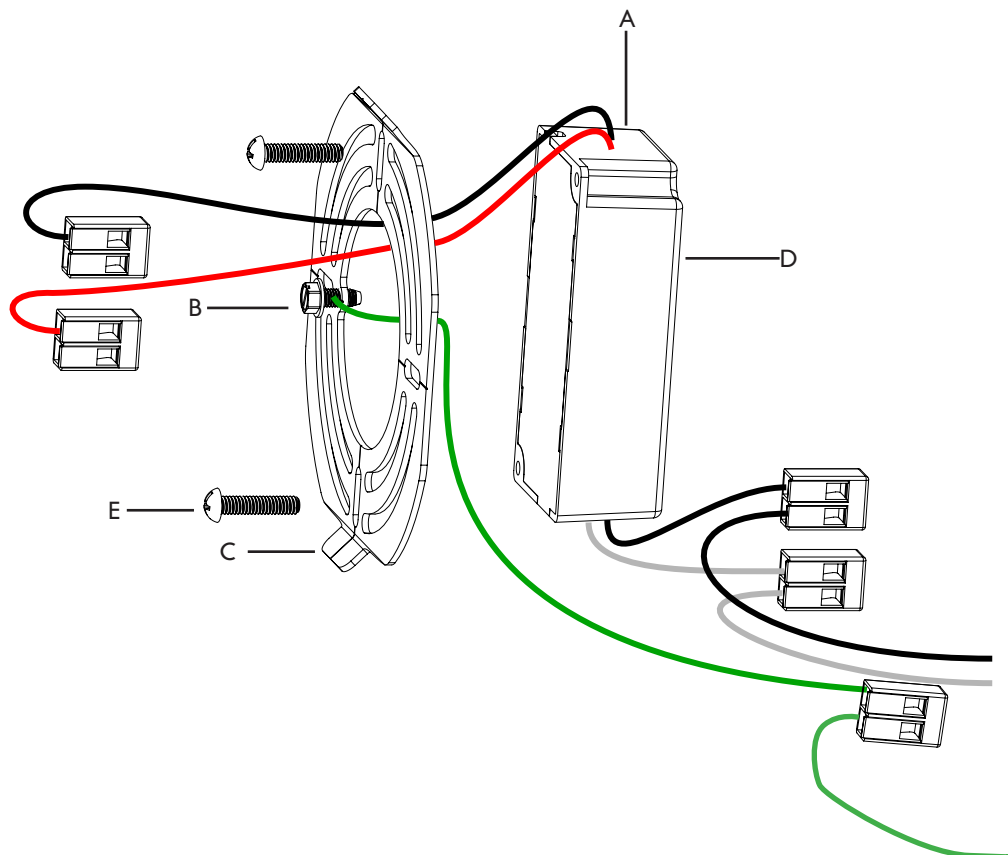

POLEL04 | INSTALLATION

Note: Please contact a licensed electrician for installation.

Note: Ensure power is off during installation.

4. Lay all the extrusions (F) down end to end. Start with the extrusion that is in the larger coverplate (G). Make sure the extrusion marked "Floor Base" is last and that the drilled hole is at the very end.

Be sure to pick them up from the mounts and not from the thin extrusion.

5. Connect the extrusions together using the provided fitters (H).

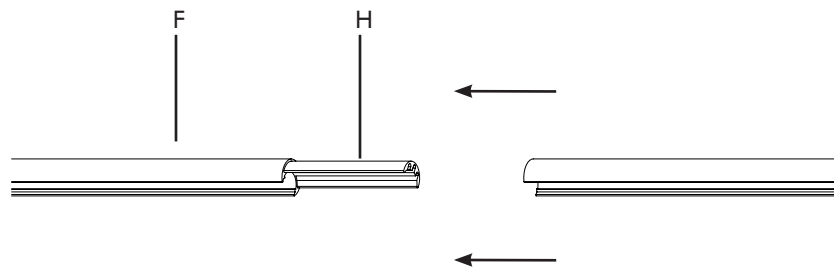

⚠ USE RUBBER Mallet ONLY ⚠
PROCEED WITH CAUTION

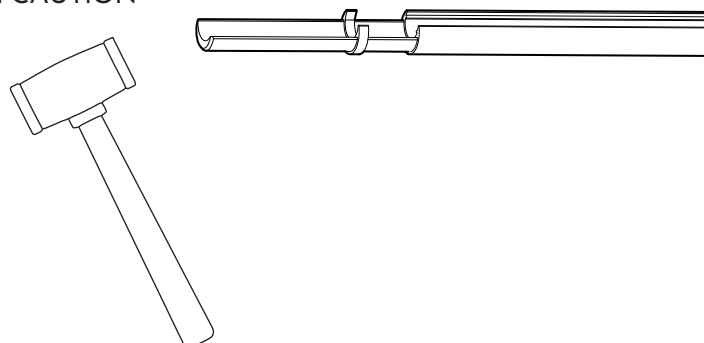

POLEL04 | INSTALLATION

Note: Please contact a licensed electrician for installation.

6. Starting from the end with the large mount, gently feed the tape in the extrusion using the roller (J). To achieve best result, roll one side of the tape first, then proceed with the other. There will be a small section of tape hanging past the end of the extrusion.

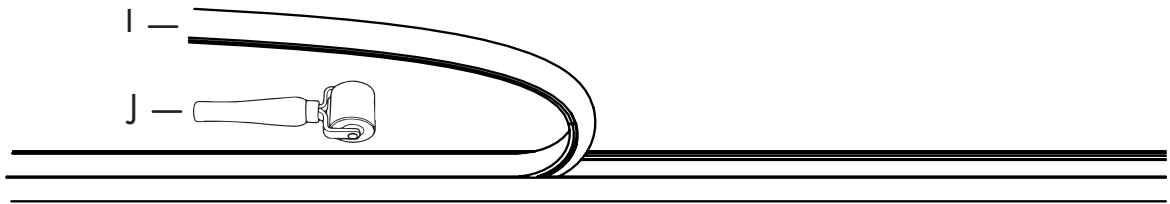

Note: Please contact a licensed electrician for installation.

7. With a pair of sharp scissors, cut the extra LED tape so it is flush with the metal extrusion. After cutting, a small amount of light may be lost at the end tip.

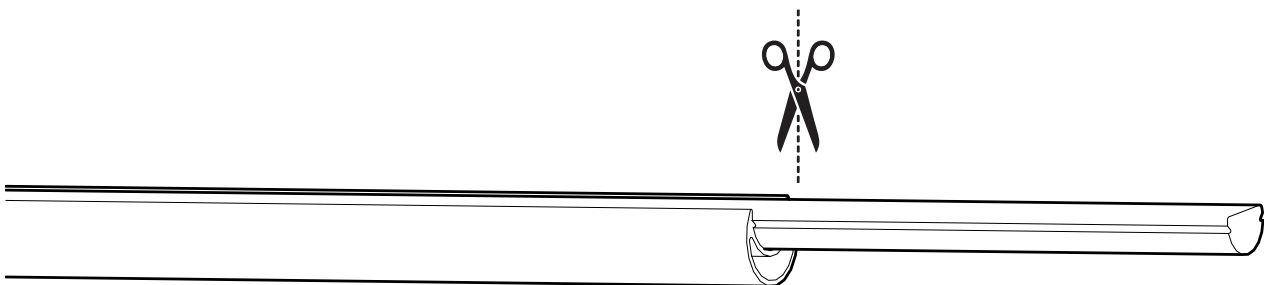

POLEL04 | INSTALLATION

Note: Please contact a licensed electrician for installation.

8. Remove the coverplate (K) from the unpowered base by removing the set screw (L) using the provided hex driver.

9. Feed the end of the extrusion through the opening on the top of the cover plate. Slide the coverplate up until the bump on the clamp (M) meets the hole in the extrusion.

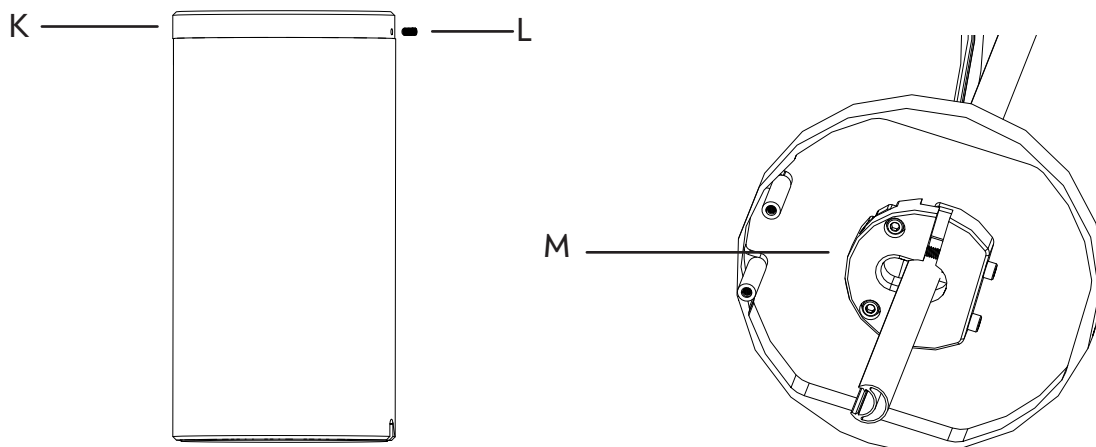

Note: Please contact a licensed electrician for installation.

10. Carefully lay the unpowered base (N) on it's sde. Slide the coverplate into place, and secure with the set screw (L)

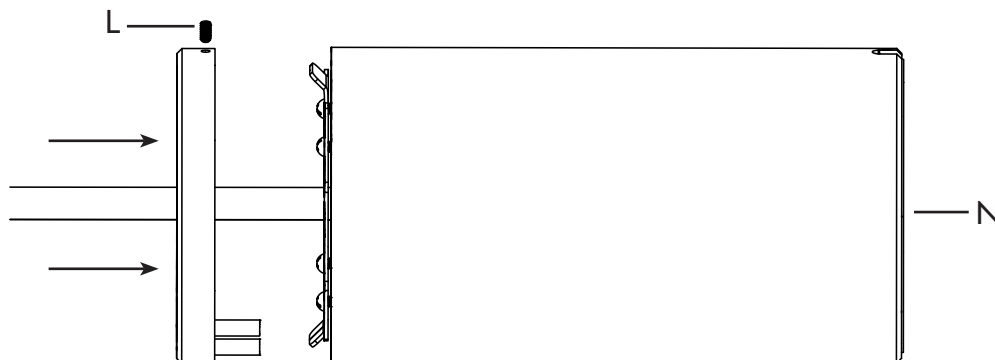

POLEL04 | INSTALLATION

Note: Please contact a licensed electrician for installation.

11. Make the connections between the powered side of the fixture and the driver wires from step 1. Mount the coverplate to the crossbar, by placing the tab from the crossbar (O) under the wedge in the coverplate. Then bring the other side of the coverplate up, and secure in place with the set screw (N). Once in place, give a gentle tug on the pole to ensure that the connection is secure.

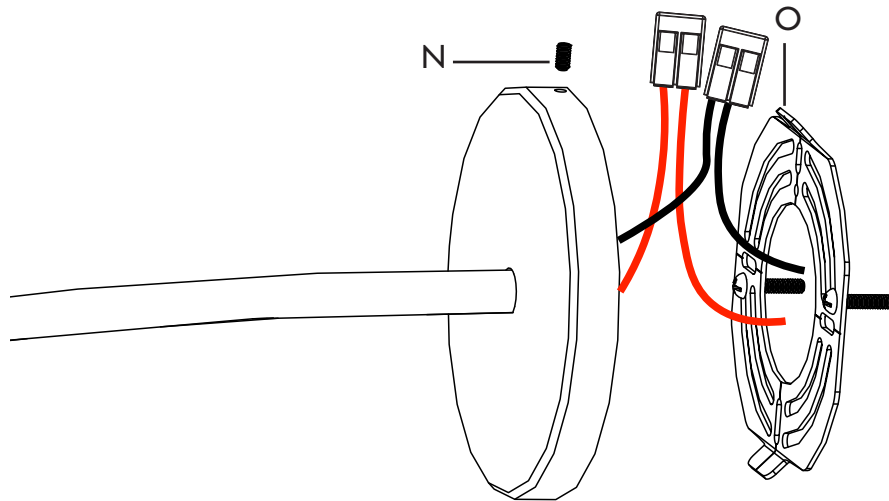

POLEL04 | INSTALLATION

Note: Please contact a licensed electrician for installation.

12. Use the spec sheet to determine the distance between the wall and the floor base.

!\ Do not vary from this recommended spacing !

