

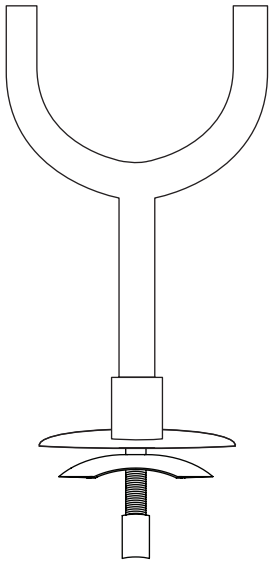

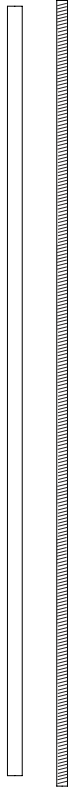

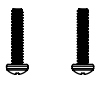

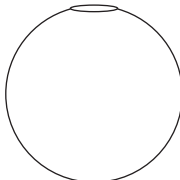
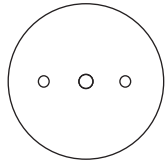
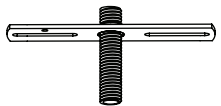

## CONTENTS

<p><b>Koko Pendant-Stem</b></p> 	<p><b>Stems and cover tubes (x2)</b></p> 	<p><b>Wago Connector</b></p> 	<p><b>Wago Connector (x2)</b></p> 
		<p><b>Glass</b></p> 	<p><b>Canopy</b></p> 
		<p><b>Crossbar with nipple assembly</b></p> 	
		<p><b>Lockwasher (x2)</b></p> 	<p><b>Nut (x2)</b></p> 
		<p><b>Bulb</b></p> 	<p><b>Canopy finial</b></p> 
<p><b>(x2) Long 8-32 screw</b> On 240V fixtures only</p> 	<p><b>(x2) Wood screw</b> On 240V fixtures only</p> 	<p><b>(x2) Metal screw</b> On 240V fixtures only</p> 	<p><b>(x2) Toggle anchor</b> On 240V fixtures only</p> 

## SAFETY INFORMATION

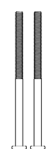
Only one light bulb per socket.  
 Only suitable for direct mounting on non-combustible surfaces.  
 Under no circumstances can Koko Pendant 1 be mounted on normally flammable surfaces.  
 Suitable for dry, indoor use only.  
 Maximum ambient temperatures: 25° C

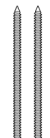
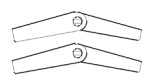
## Stem and cover tube length adjustment

---

*Note: Please contact a licensed electrician.*

### Example fixture only:

To measure length of stem, first determine overall length (OAL), subtract 1" for the canopy height and subtract the fixture height from the OAL. Fixture height is measured from bottom of the fixture to stem connection point.

The resulting measurement is the final stem length.

Ex. The fixture below has an OAL of 40" and a fixture height of 15".

$$40'' \text{ OAL} - .5'' \text{ canopy} - 15'' \text{ fixture height} = 24.5'' \text{ stem}$$

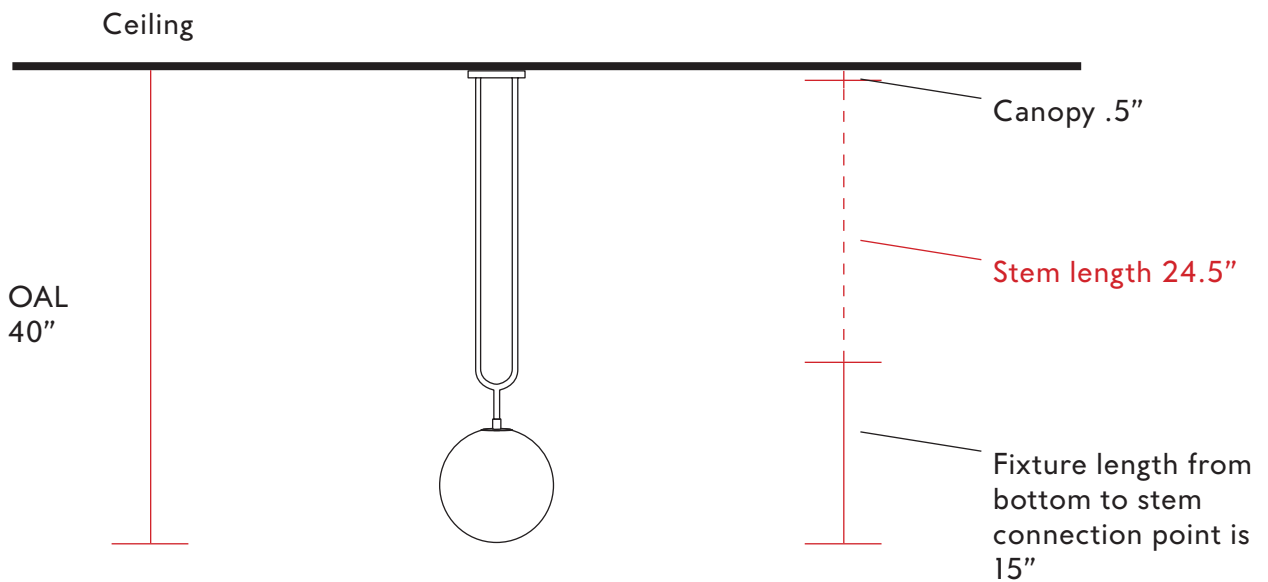

## Stem and cover tube length adjustment

---

*Note: Please contact a licensed electrician.*

### Example fixture only:

1. To customize the length of the provided stem, cut cover tube to desired length. Then cut the inner threaded tube so that it remains 1" longer than the cover tube.

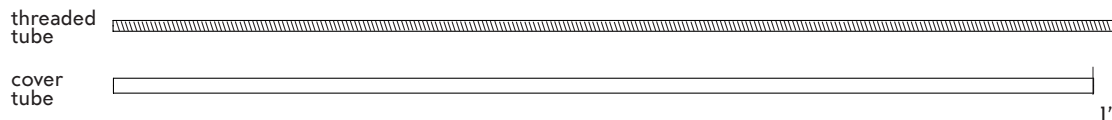

2. Mark the length of the tube required, using a marker or tape. Then hold down the tube with a hand or a clamp, use a hacksaw or electrical tool to cut the tube. Recommended to clean tube after cutting to remove any metal chippings.

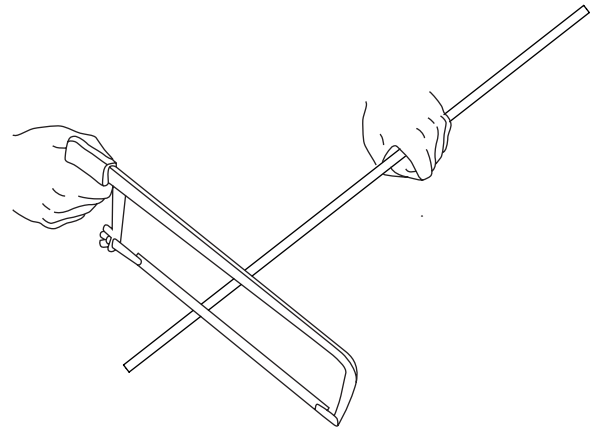

3. Now that the cover tube is cut to 24.5", measure the all thread tube to be 25.5" long. And place a mark, with a marker or tape.

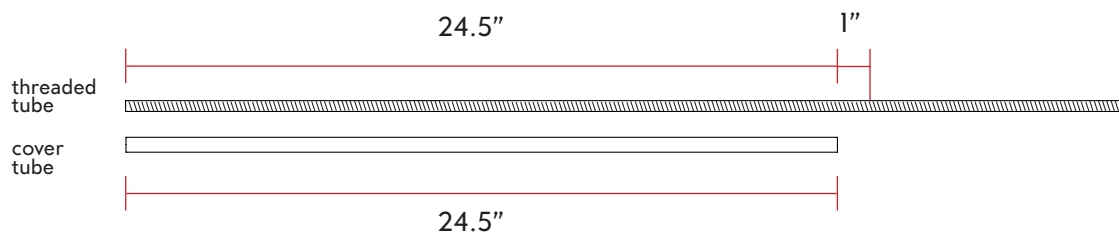

4. Hold down the all thread with a hand or a clamp, use a hacksaw or electrical tool to cut the all thread tube. Recommended to clean all thread tube after cutting to remove any metal chippings.

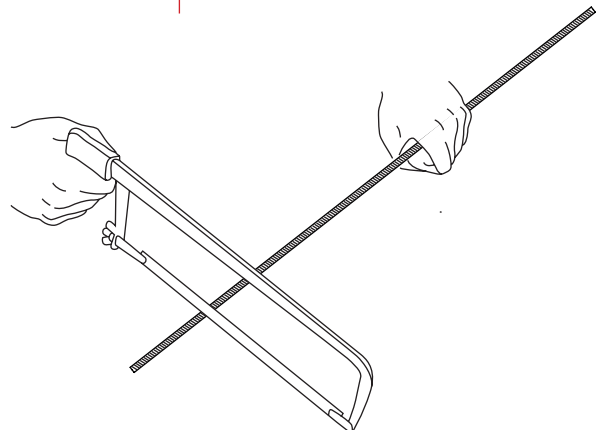

## CEILING INSTALLATION | KOKO PENDANT 1

*Note: Please contact a licensed electrician.*

1. After the stems are cut to length, feed the wires from the fixture (A), through the threaded rod (B), and cover tube (C), and screw in the threaded rod into the fixture.
2. Fit the canopy (D) over the top of the stems, then secure the canopy with lock-washer (E) and nut (F).

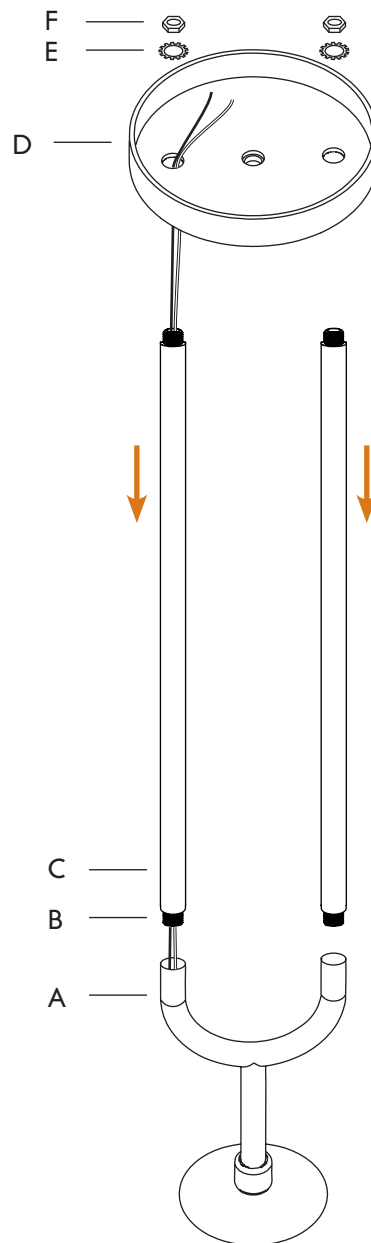

## CEILING INSTALLATION | KOKO PENDANT 1

---

*Note: Please contact a licensed electrician.*

3. Attach the crossbar (G) to the J-box (H) using two screws (I).
4. Connect the ground wire to crossbar using the provided 2 port wago (J).  
Be sure to pull out the lead wires.

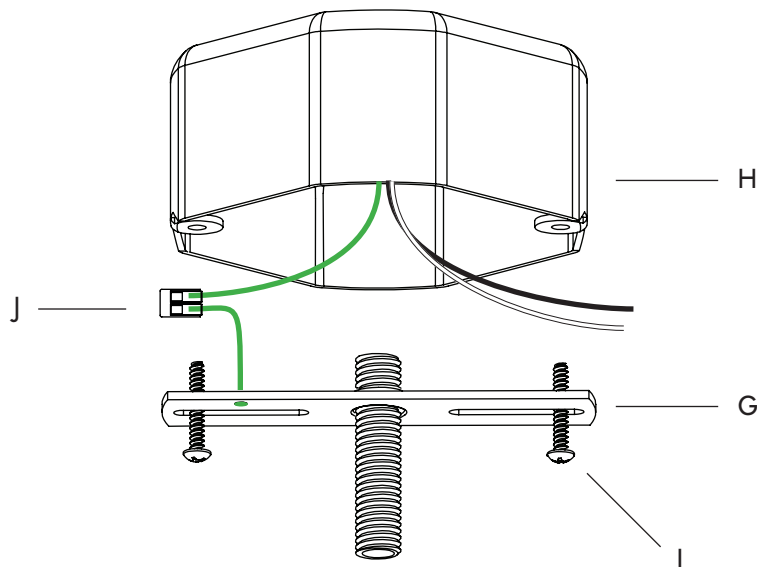

## CEILING INSTALLATION | KOKO PENDANT 1

*Note: Please contact a licensed electrician.*

5. Raise the canopy (D) to the J-box (H), and make the electrical connection using the provided 2 port wagos (K).
6. Tuck the wires inside the canopy and fit the canopy over the nipple (L), then secure it with a finial (M).

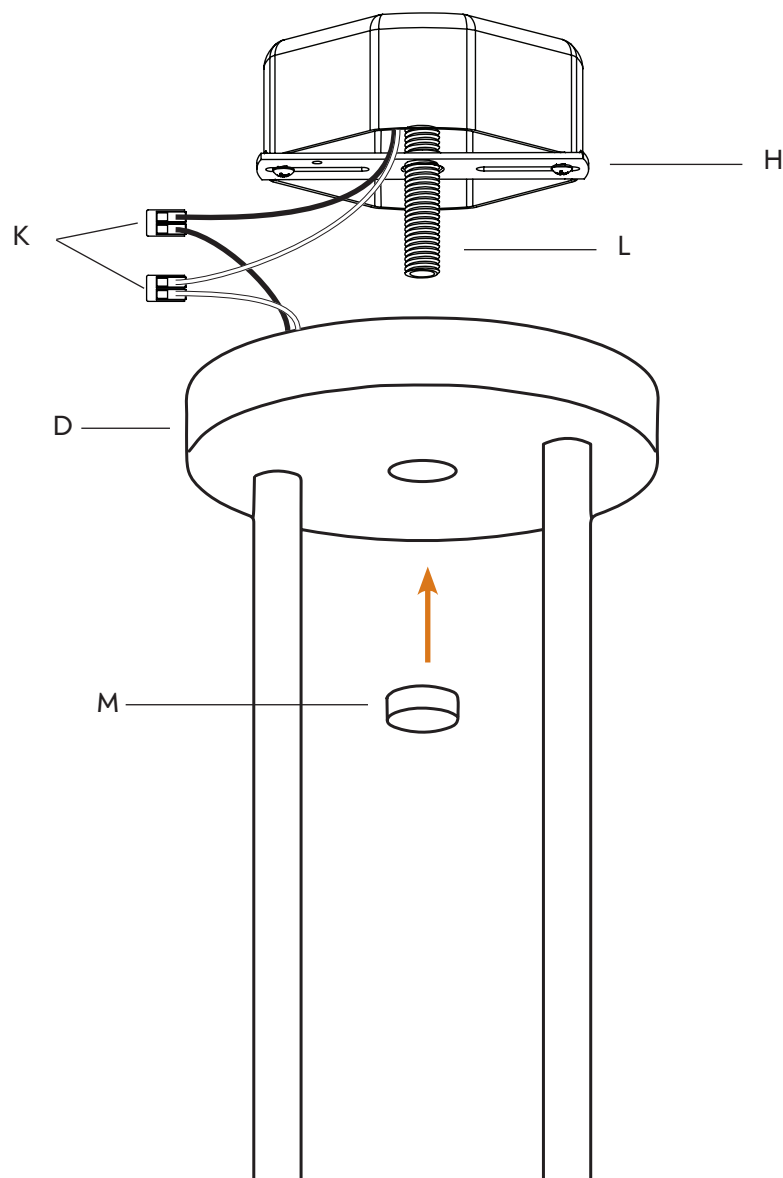

## GLASS INSTALLATION

---

*Note: Please contact a licensed electrician.*

1. Sandwich the glass globe (A) around the socket fitter (B) and cap (C).
2. Gently tighten the sleeve (D) to hold the globe in place.

