

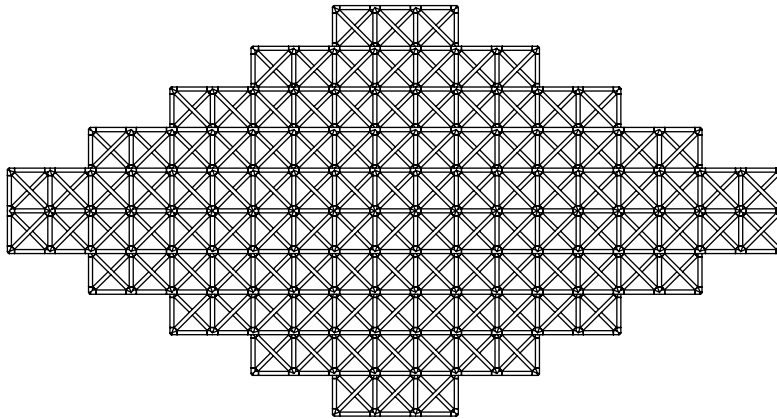

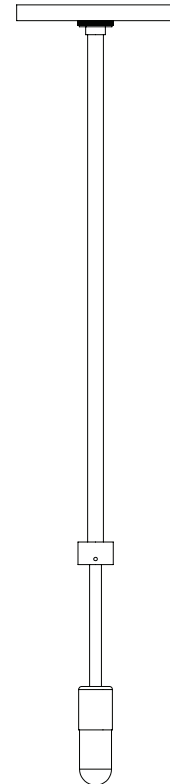

CONTENTS

Gridlock 7440

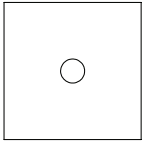
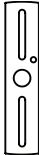

Bulb Stem



<p>Canopy</p> 	<p>Crossbar</p> 	<p>Nut</p> 	<p>G9 Bulb - 60W (240V not included)</p> 
		<p>Collar</p> 	<p>8-32 Screws (2)</p> 

SAFETY INFORMATION

Only one light bulb per socket.
 Only suitable for direct mounting on non-combustible surfaces.
 Under no circumstances can Gridlock Pendants be mounted on normally flammable surfaces.
 Suitable for dry, indoor use only.
 Maximum ambient temperatures: 25° C

GRIDLOCK 1912, 4059, 7440 | CEILING INSTALLATION

Note: Please contact a licensed electrician.

Note: Do not use bulbs that exceed 60 watts for Gridlock 1912 and 4059

Do not use bulbs that exceed 100 watts for Gridlock 7440

1. Install the crossbar using #8-32 screws to junction box (A). It is recommended to make the wire connections after installing the crossbar (B).
2. Once the crossbar is secure, tuck the connected wires into the Junction box (A) and raise the canopy (C) and the hang-straight nut (D). Thread the nut onto the hangstraight, tightening the canopy flush to the ceiling.

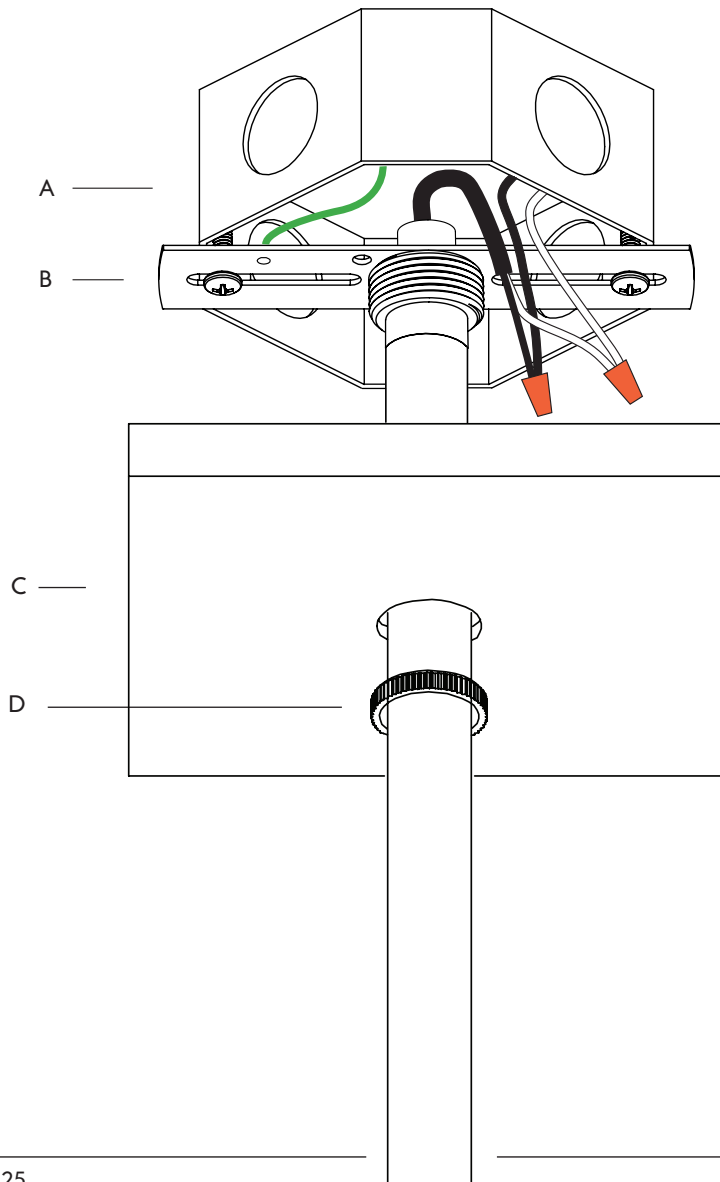

GRIDLOCK 1912, 4059, 7440 | CEILING INSTALLATION

Note: Please contact a licensed electrician.

Note: Do not use bulbs that exceed 60 watts for Gridlock 1912 and 4059

Do not use bulbs that exceed 100 watts for Gridlock 7440

After installing the bulb stem (A) to the crossbar, bring the Gridlock cage (B) up through the middle and capture the nut (C) between the threaded collar (D) and clamp (E) by threading them together.

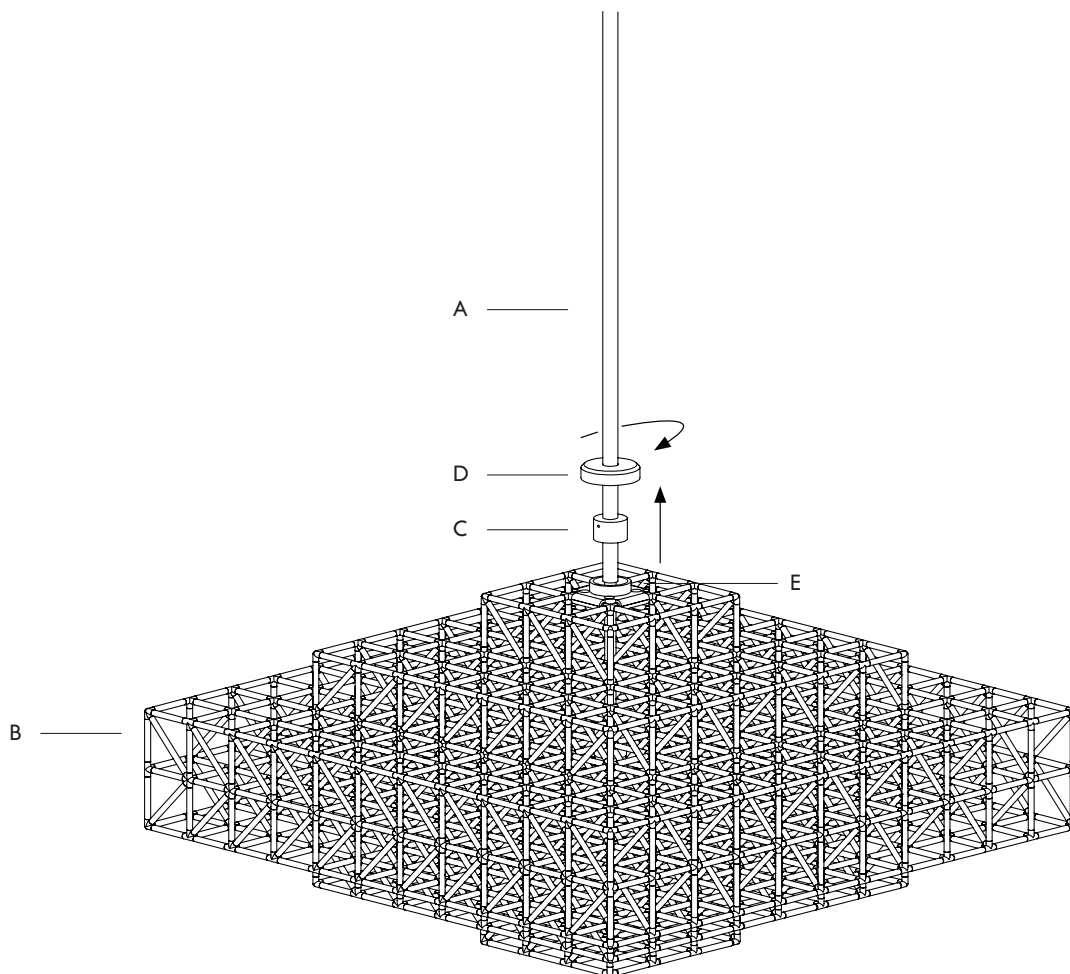

GRIDLOCK | REPLACING BULB

Note: Make sure to power off fixture and allow bulbs and metal arms to cool.

To change the halogen G4 bulb (A), take off the pendant cage (see installation instructions page) then unscrew the glass cover (B) and pull out the bulb from the socket (C).

