

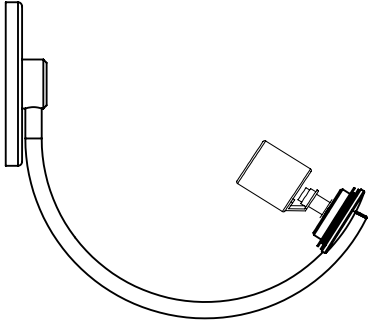





CONTENTS

<p>Fiddlehead Sconce Fixture</p> 	<p>Collar</p> 	
<p>Globe</p> 	<p>Crossbar</p> 	<p>Canopy</p> 
<p>Wago Connector (2)</p> 	<p>8-32 Crossbar Screws (2)</p> 	<p>8-32 Finished Screws (2)</p> 
<p>A19 Bulb</p>  <p>Incandescent 120V (bulbs included) Incandescent 240V (bulbs not included)</p>		

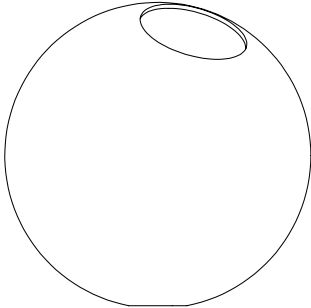
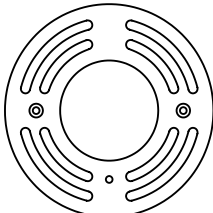
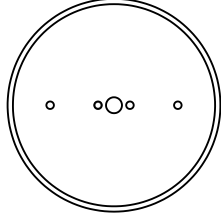
SAFETY INFORMATION

Only one light bulb per socket.

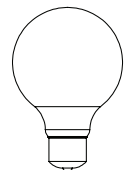
Only suitable for direct mounting on non-combustible surfaces.

Under no circumstances can Fiddlehead Cantilever be mounted on normally flammable surfaces.

Suitable for dry, indoor use only.

Maximum ambient temperatures: 25° C

FIDDLEHEAD SCONCE | INSTALLATION

*Note: Please contact a licensed electrician.
Note: Do not use bulbs that exceed 60 watts.*

1. Secure custom crossbar (D) to junction box (F) with two provided 8-32 screws (G)
2. Connect fixture to wall power and ground (C) (E). After making connections tuck wire into junction box through center hole in crossbar.
3. Secure fixture canopy (B) to crossbar (D) using 8/32 finished screws (A)

Note: Follow instructions to install glass globe after securing fixture.

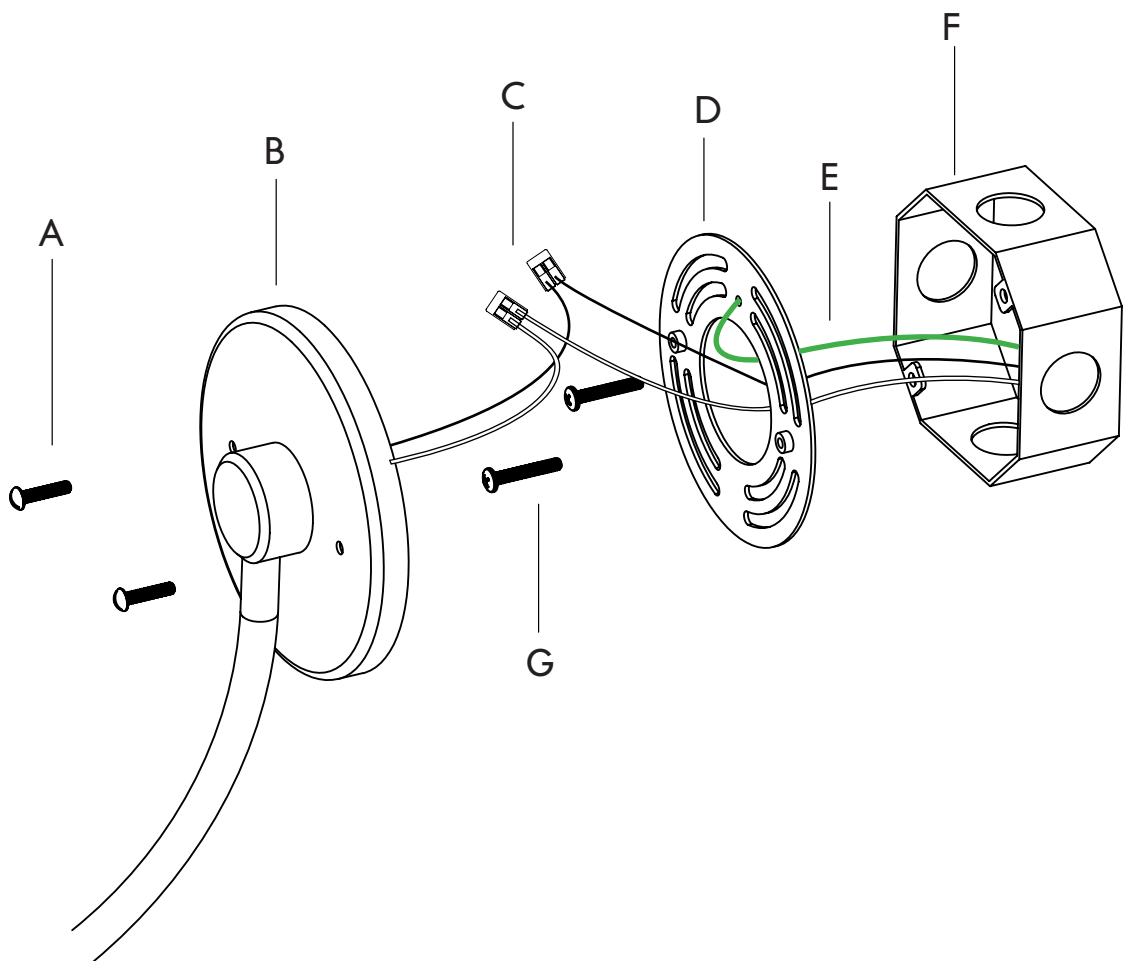

INSTALLING THE GLASS GLOBE

Note: If changing bulb, make sure to power off fixture and allow bulbs and metal arms to cool.

1. To install the glass globe (A), hold fixture steady and carefully place the small hole of the globe over the socket (B).
2. Inside the globe, place the plastic washer (C) over the threaded socket (D) and insert the collar (E) through the large hole and thread on to socket (D).
3. To adjust the position of the globe lightly loosen the collar (E) and rotate so the large hole is to the left or right of the tube.
4. To install or change the bulb (F), reach through the large globe hole and screw into socket.

