

## CONTENTS

---

Delta 5" Flushmount

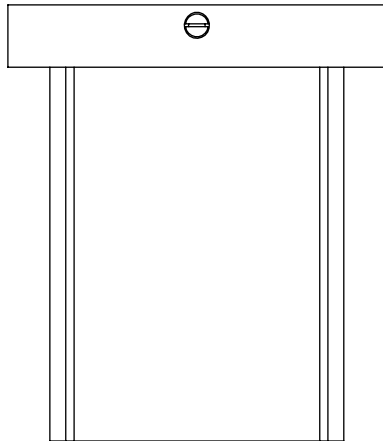

Crossbar

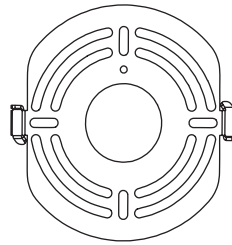

(x3) Wago Connector



(x2) Brass Screws

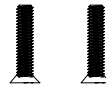

(x2) #8-32 Screws

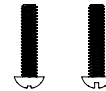

Green Ground Screw



Terminal Ring and Ground wire



## SAFETY INFORMATION

---

Only one light bulb per socket.

Only suitable for direct mounting on non-combustible surfaces.

Under no circumstances can Delta 5" be mounted on normally flammable surfaces.

Suitable for dry, indoor use only.

Maximum ambient temperatures: 25° C

## DELTA 5" FLUSHMOUNT | INSTALLATION

---

*Note: Please contact a licensed electrician.*

01. Attach the crossbar (A) to the junction box (B) with provided screws (C)  
Be sure to feed the wires through the crossbar center opening.
02. Connect the ground wire to the crossbar with provided two port wago (D)

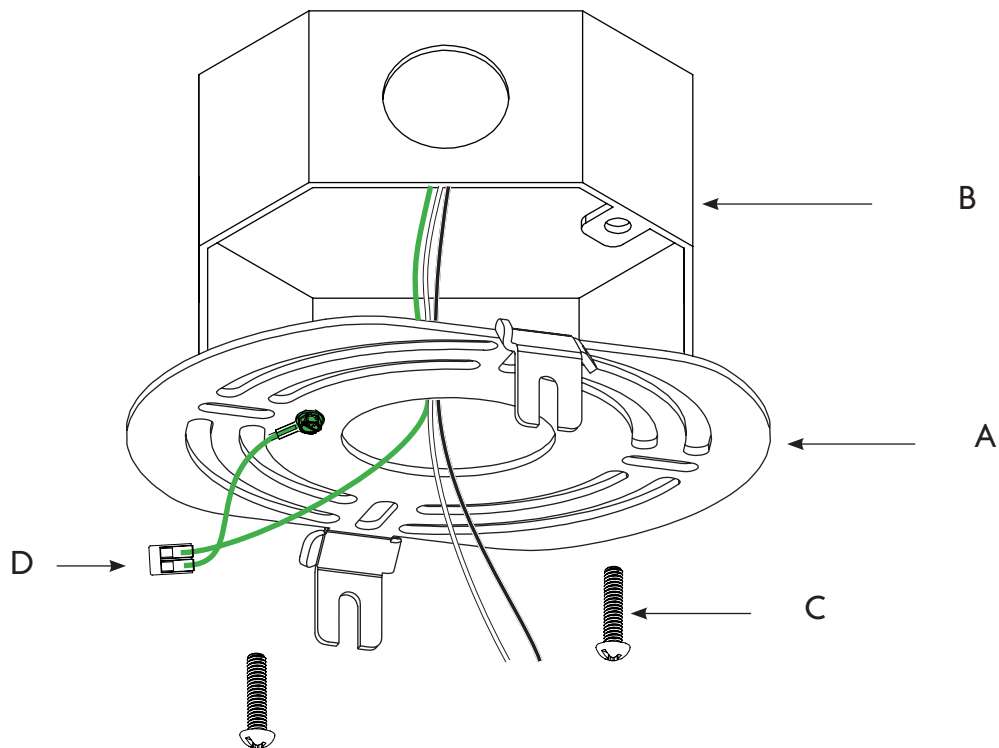

## DELTA 5" FLUSHMOUNT | INSTALLATION

---

*Note: Please contact a licensed electrician.*

03. Lift the fixture (E) up to the crossbar (A), and connect the red and black wires with provided two port wagos (F).
04. Fit all wiring into the fixture canopy, then raise the fixture over the crossbar (A), be sure to align the canopy wedges with crossbar cleat (G) and twist counter clockwise to fit the wedges onto the crossbar cleats
05. Then secure the fixture with the provided two screws (H).

