

CONTENTS

Del Playa Stemmed Assembly

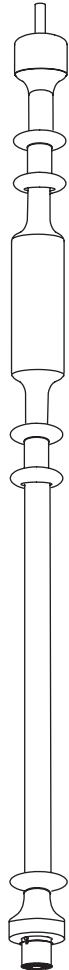

2" Diffuser

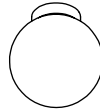

(x2) 8-32 J box Screw



(x5) Wago Connectors



Del Playa Shade

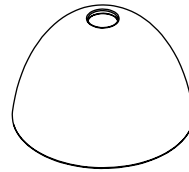

Canopy nut

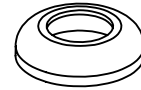

Canopy with crossbar assembly

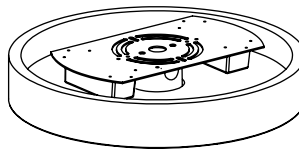

Collar



O-ring



(x2) Toggle anchor
On 240V fixtures only

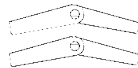

(x2) Wood screw
On 240V fixtures only



(x2) Long 8-32 screw
On 240V fixtures only

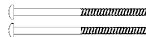

(x2) Metal screw
On 240V fixtures only



SAFETY INFORMATION

Suitable for dry, indoor use only.

Maximum ambient temperature: 25°C

The light source contained in this luminaire shall only be replaced by the manufacturer or his service agent or a similar qualified person.

DEL PLAYA PENDANT STEMMED | INSTALLATION

Stem and cover tube length adjustment

Note: Please contact a licensed electrician.

Example fixture only:

To measure length of stem, first determine overall length (OAL), subtract 16.4" for the canopy with top stem height and subtract the fixture height from the OAL. Fixture height is measured from bottom of the fixture to stem connection point. The resulting measurement is the final stem length.

Ex. The fixture below has an OAL of 40" and a fixture height of 8".
 $40'' \text{ OAL} - 16.4'' \text{ canopy \& top stem} - 8'' \text{ fixture height} = 15.6'' \text{ adjustable stem}$

NOTE: The adjustable stem part is necessary for proper connection, the shortest it can be cut down to is approximately 1"

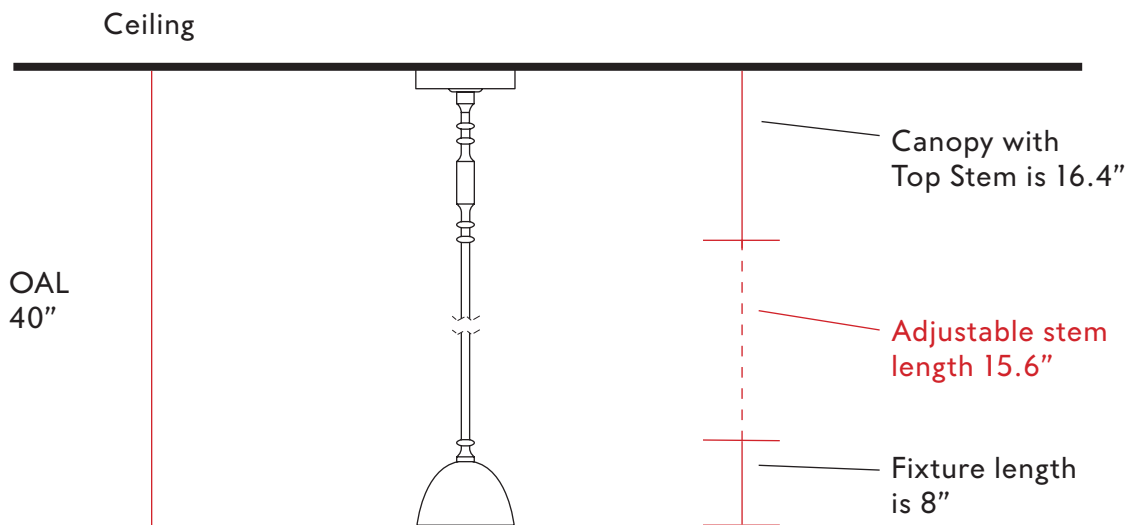

DEL PLAYA PENDANT STEMMED | INSTALLATION

Stem and cover tube length adjustment

Note: Please contact a licensed electrician.

Example fixture only:

1. To customize the length of the provided stem, cut cover tube to desired length. Then cut the inner threaded tube so that it remains 19" longer than the cover tube.

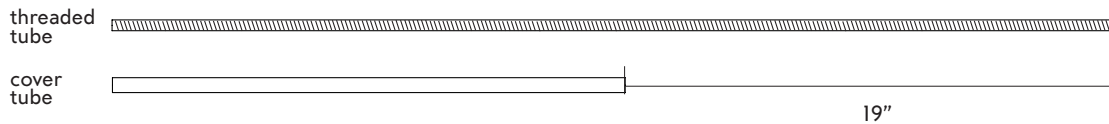

2. Mark the length of wood tube required, using a marker or tape. Then hold down the tube with a hand or a clamp, use a hacksaw or electrical tool to cut the tube. Recommended to clean tube after cutting to remove any chippings.

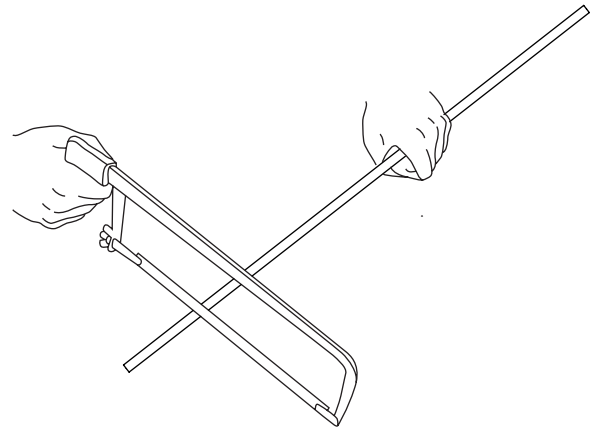

3. Now that the cover tube is cut to 15.6", measure the all thread tube to be 15.6 plus 19" long. And place a mark, with a marker or tape.

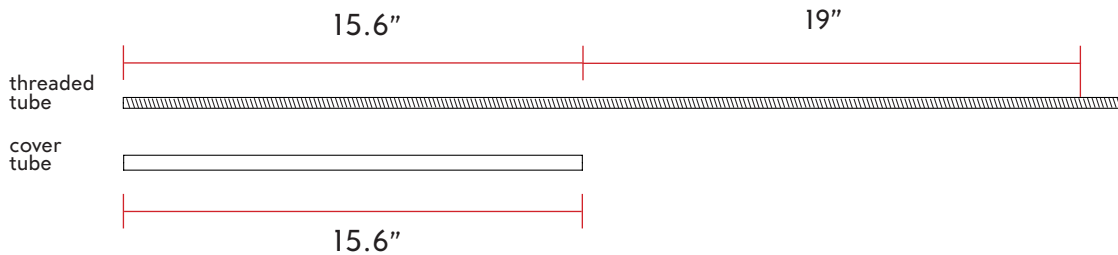

4. Hold down the all thread with a hand or a clamp, use a hacksaw or electrical tool to cut the all thread tube. Recommended to clean all thread tube after cutting to remove any metal chippings.

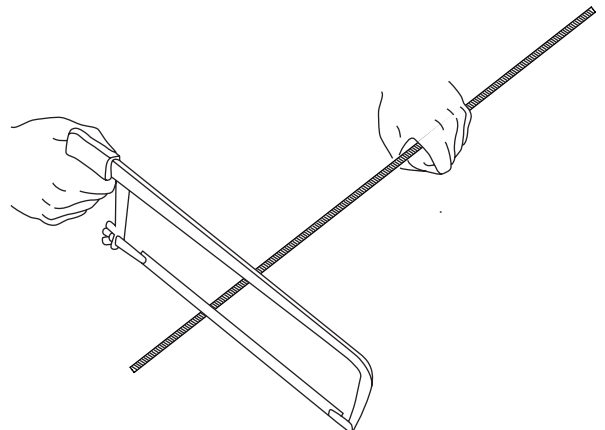

DEL PLAYA PENDANT STEMMED | INSTALLATION

Note: Please contact a licensed electrician.

1. Unscrew the canopy nut (A) counter-clock wise, to release the canopy (B) from the crossbar (C).
2. Bring the crossbar up to the J-box (D), and connect the ground wire (E), and pull out the lead wires (F) through one of the openings in the crossbar.
3. Secure the crossbar to J-box with the two provided screws (G).

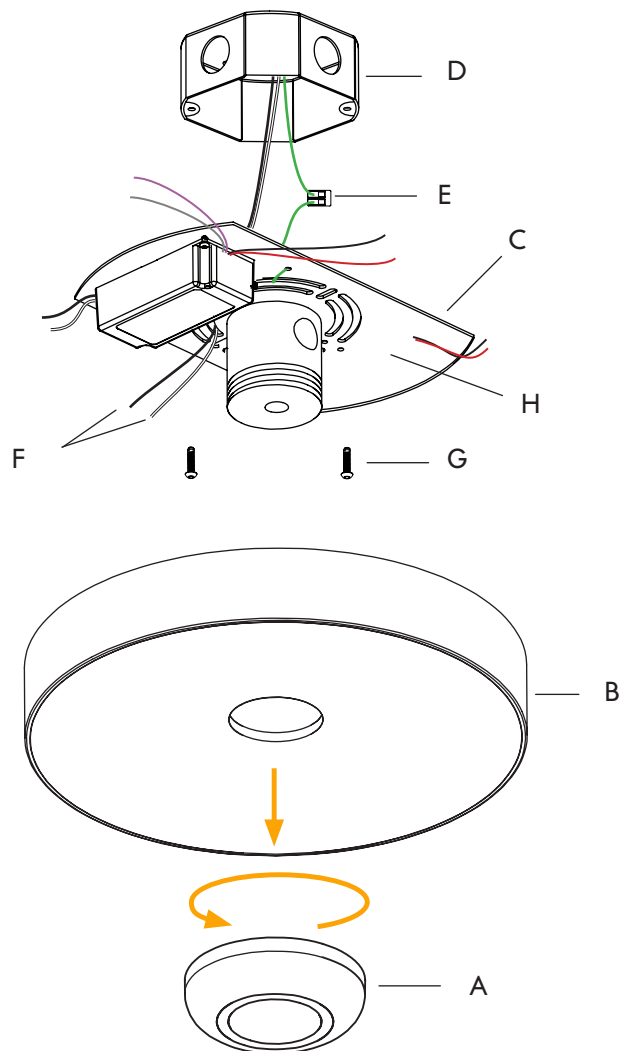

DEL PLAYA PENDANT STEMMED | INSTALLATION

Note: Please contact a licensed electrician.

4. Bring the fixture assembly (I) to the crossbar (C), and feed the low voltage wires through the large hickey (J).
6. Connect the low voltage wires using the provided 2-port wagos (K).
5. Connect the lead wire using the provided 2-port wagos (L).
7. Optional: connect the dimming wires using the provided 2-port wagos (M).
8. After all wires are connected, bring the canopy (B) up to the crossbar, and secure it with canopy nut in a clock wise direction.

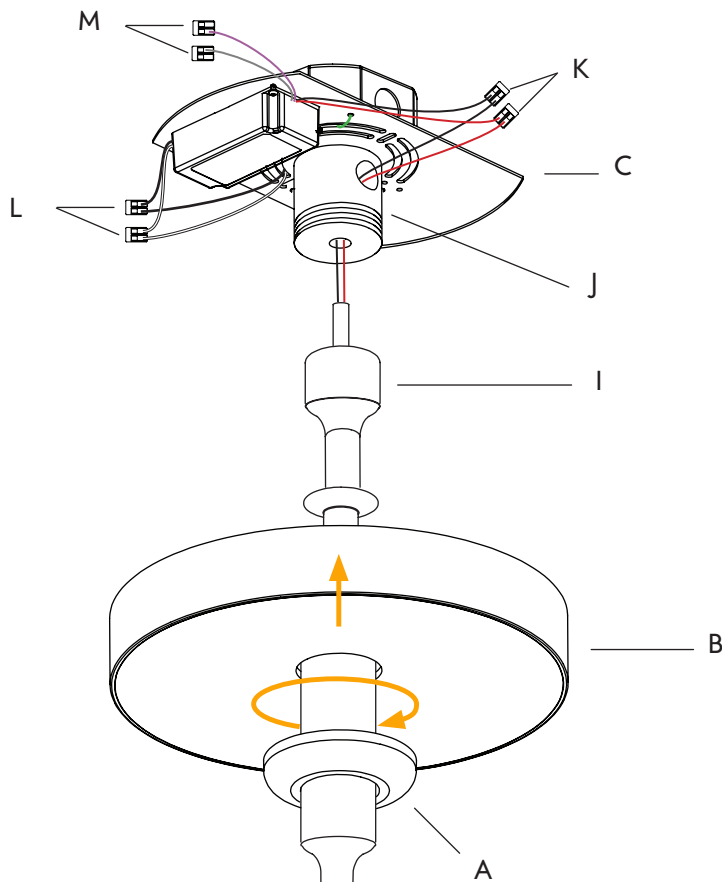

DEL PLAYA PENDANT STEMMED | INSTALLATION

SHADE INSTALLATION

1. Fit the shade (A) onto the LED cup (B), and secure it with O-ring (C) and collar (D).
2. Then screw on the LED diffuser (E).

