

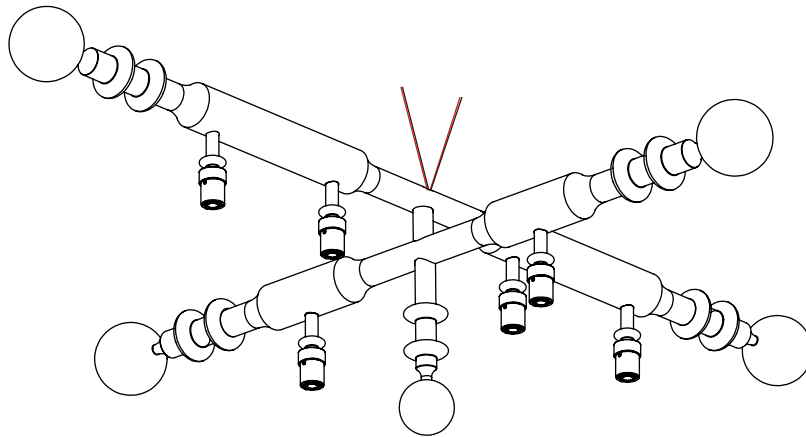

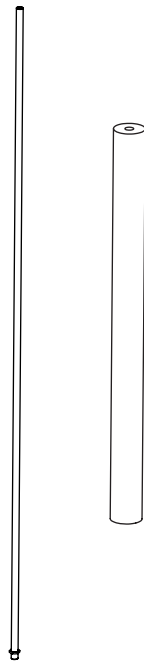





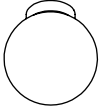

CONTENTS

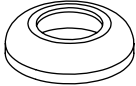
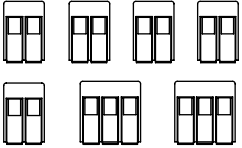
Del Playa 4 Arm Pendant Assembly

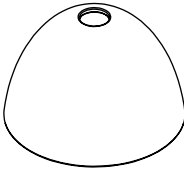
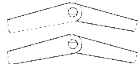

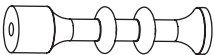
Threaded rod with nut,
and wooden center stem

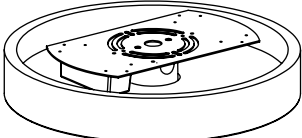

<p>(6x) 2" Diffuser</p> 	<p>(x2) 8-32 J box Screw</p> 	<p>Canopy nut</p> 	
<p>(x7) Wago Connectors</p> 	<p>(6x) Collar and O-ring</p> 	<p>(6x) Del Playa Shade</p> 	<p>(x2) Toggle anchor On 240V fixtures only</p>  <p>(x2) Wood screw On 240V fixtures only</p> 
<p>Top stem</p> 	<p>Bottom stem</p> 	<p>Canopy assembly</p> 	<p>(x2) Long 8-32 screw On 240V fixtures only</p>  <p>(x2) Metal screw On 240V fixtures only</p> 

SAFETY INFORMATION

Suitable for dry, indoor use only.

Maximum ambient temperature: 25°C

The light source contained in this luminaire shall only be replaced by the manufacturer or his service agent or a similar qualified person.

DEL PLAYA 4 ARM PENDANT | INSTALLATION

Stem and cover tube length adjustment

Note: Please contact a licensed electrician.

Example fixture only:

To measure length of stem, first determine overall length (OAL), subtract 3" for the canopy with hang-straight height and subtract the fixture height from the OAL. Fixture height is measured from bottom of the fixture to stem connection point. The resulting measurement is the final stem length.

Ex. The fixture below has an OAL of 40" and a fixture height of 21.7".
 $40'' \text{ OAL} - 4.3'' \text{ canopy} - 21.7'' \text{ fixture height} = 14'' \text{ stem}$

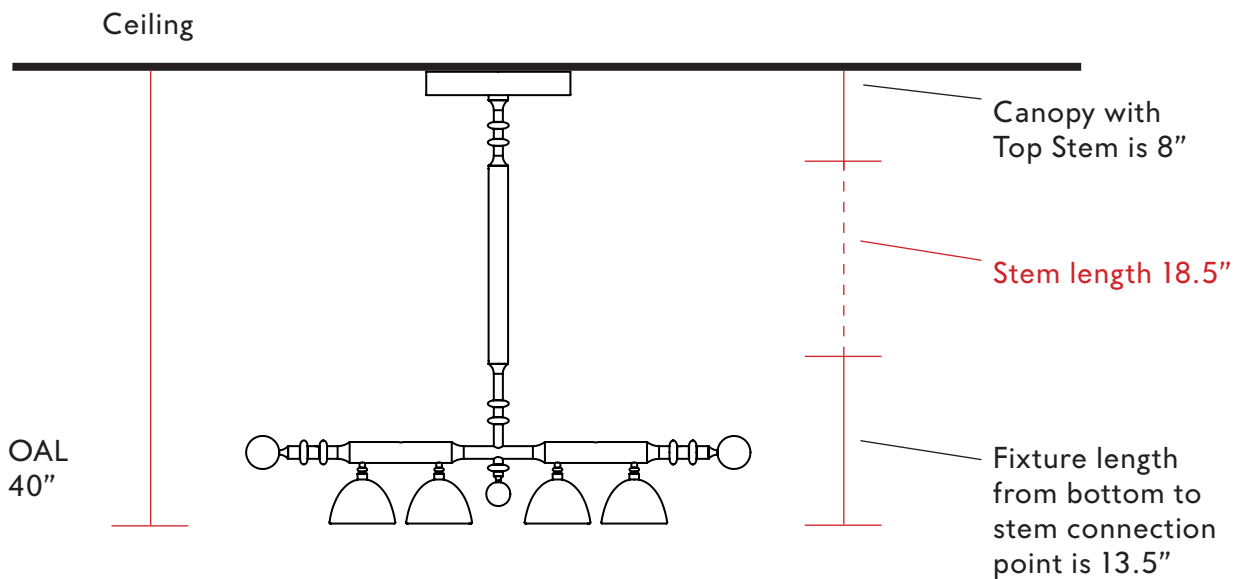

DEL PLAYA 4 ARM PENDANT | INSTALLATION

Stem and cover tube length adjustment

Note: Please contact a licensed electrician.

Example fixture only:

1. To customize the length of the provided stem, cut cover tube to desired length.
Then cut the inner threaded tube so that it remains 1/2" longer than the cover tube.

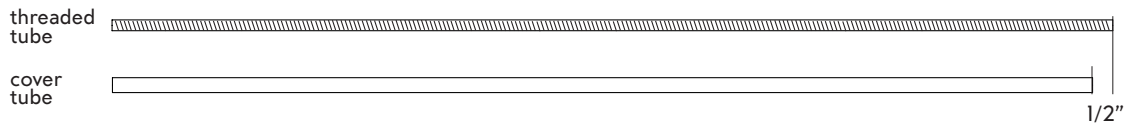

2. Mark the length of the tube required, using a marker or tape. Then hold down the tube with a hand or a clamp, use a hacksaw or electrical tool to cut the tube. Recommended to clean tube after cutting to remove any metal chippings.

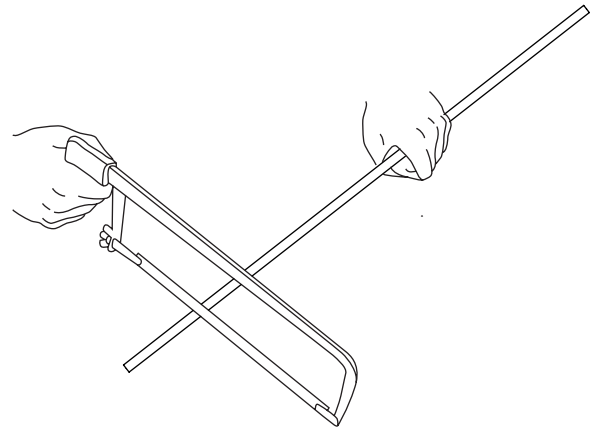

3. Now that the cover tube is cut to 18.5", measure the all thread tube to be 18.5 and 1/2" long. And place a mark, with a marker or tape.

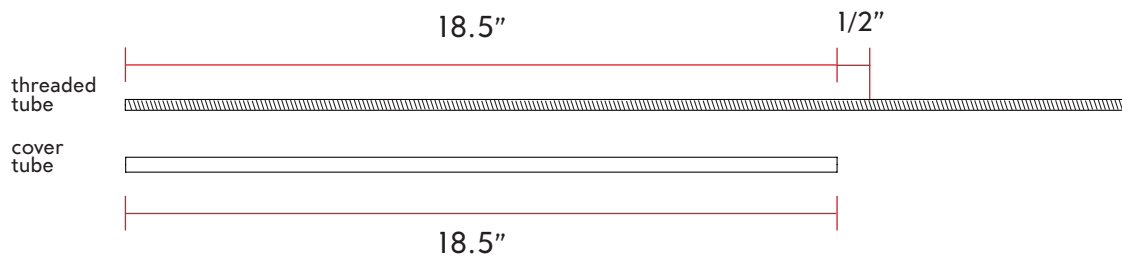

4. Hold down the all thread with a hand or a clamp, use a hacksaw or electrical tool to cut the all thread tube. Recommended to clean all thread tube after cutting to remove any metal chippings.

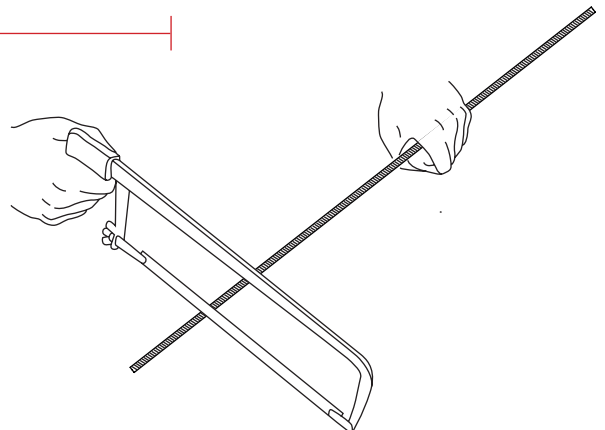

DEL PLAYA 4 ARM PENDANT | INSTALLATION

Note: Please contact a licensed electrician.

1. Screw in the threaded rod with a nut at one end (A) into the center hole on the fixture (B).
Make sure to tighten in as much as possible.
2. Slide the bottom stem (C), then the center stem (D), and the top stem (E), onto the threaded rod (A).

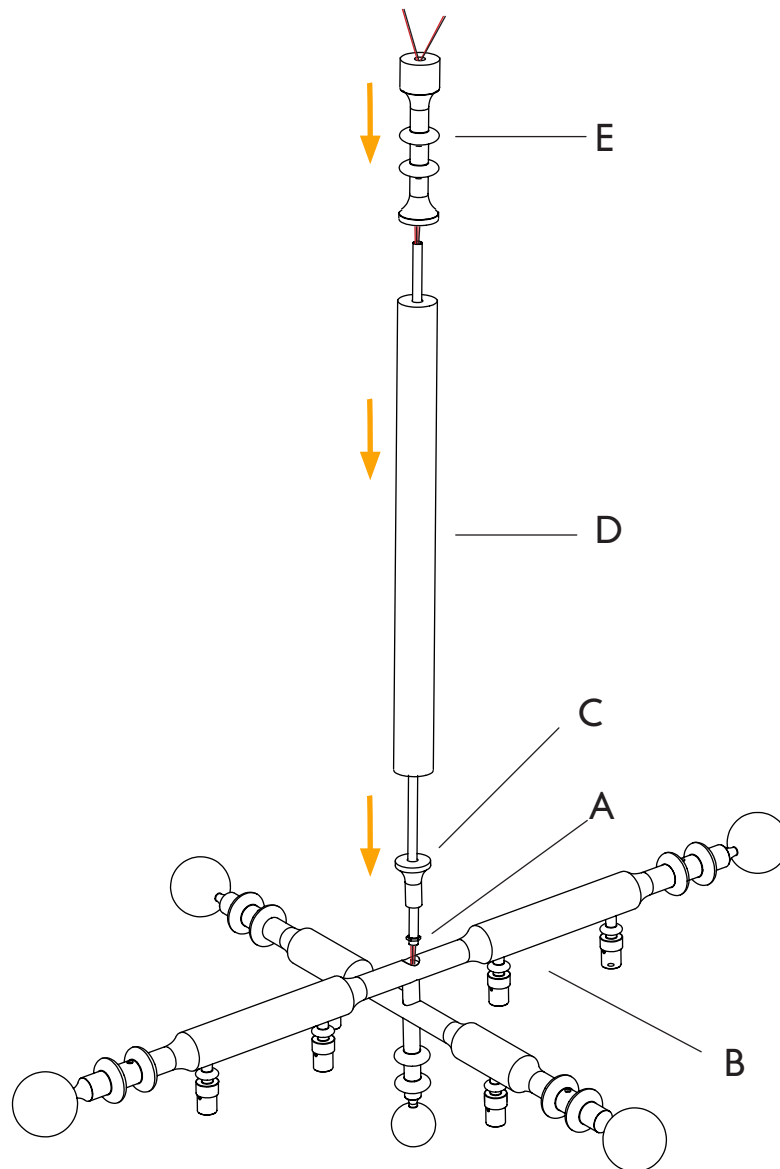

DEL PLAYA 4 ARM PENDANT | INSTALLATION

Note: Please contact a licensed electrician.

3. (As seen in figure 1) From the canopy assembly, unscrew the canopy nut (F), to release the canopy (G), and crossbar (H).
4. Slide the canopy nut (F), and canopy (G), onto the stem (I).
5. Feed the wires from the threaded rod (A), through the nipple in crossbar (H).
DO NOT make any wire connections yet.
6. Then screw on the crossbar onto the threaded rod (A). Be sure not to crimp any wires.

Figure 1

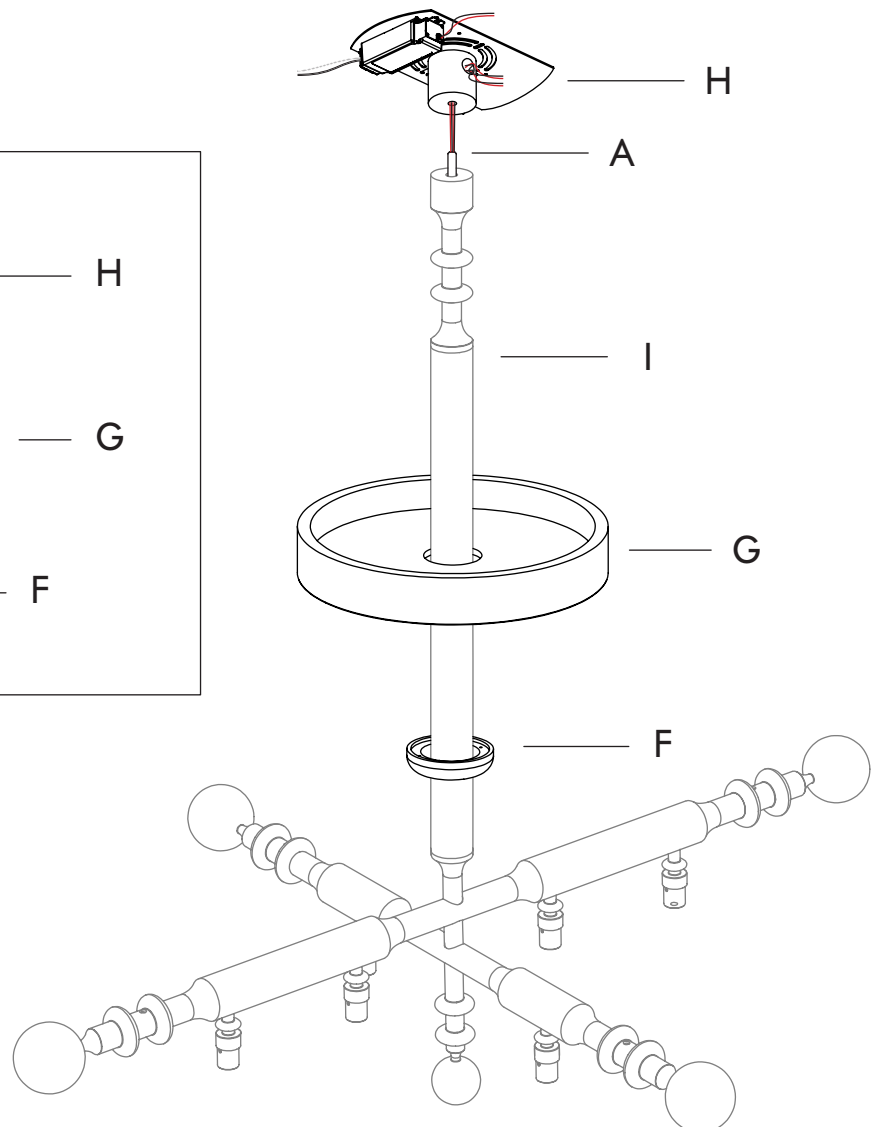
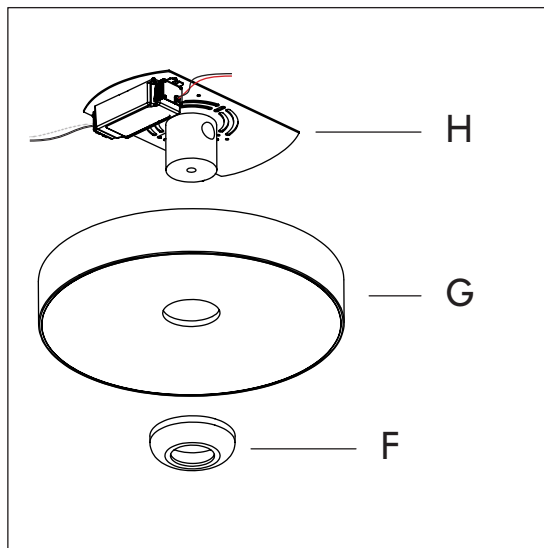

DEL PLAYA 4 ARM PENDANT | INSTALLATION

Note: Please contact a licensed electrician.

7. Raise the fixture up to the ceiling, and fit the crossbar (H) over the J-box (J), feed the lead wires from the J-box through the crossbar.
8. Then secure the crossbar to J-box with two provided screws (L).
9. Next, connect the low voltage wires from the fixture to the LED driver using two 3-port wagos (M), and connect the lead wires from the LED driver to the J-box lead wires using two 2-port wagos (N).
10. Connect the ground wires using 2-port wago. (Optional dimming wire connections (P)).

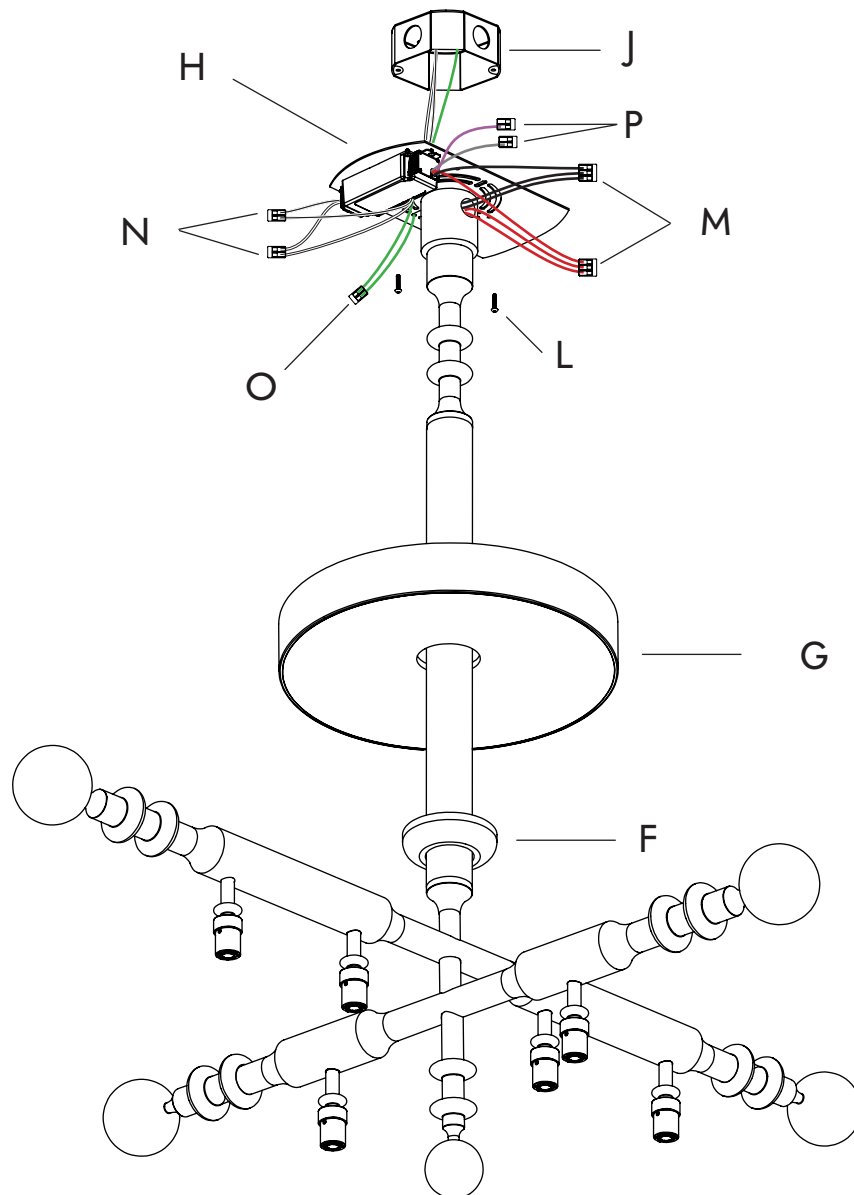

DEL PLAYA 4 ARM PENDANT | INSTALLATION

Note: Please contact a licensed electrician.

11. After all the connections have been made, raise the canopy (G) over the crossbar, and tuck all the wires inside. Then secure the canopy with a canopy nut (F).

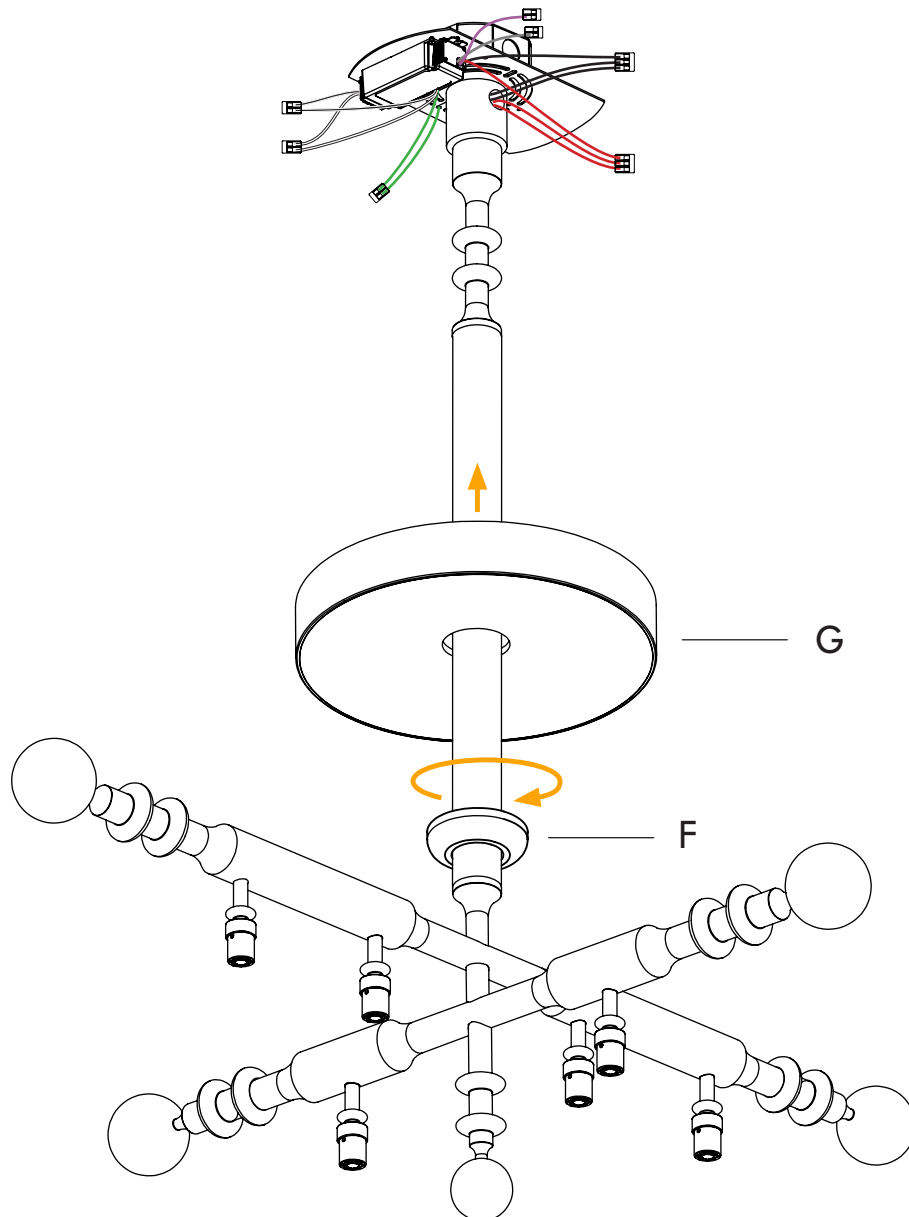

DEL PLAYA 4 ARM PENDANT | INSTALLATION

SHADE INSTALLATION

1. Fit the shade (A) onto the LED cup (B), and secure it with collar (C) and O-ring (D). Then screw on the LED diffuser (E).

