

## CONTENTS

---

Cross 3 (Parts A & B)

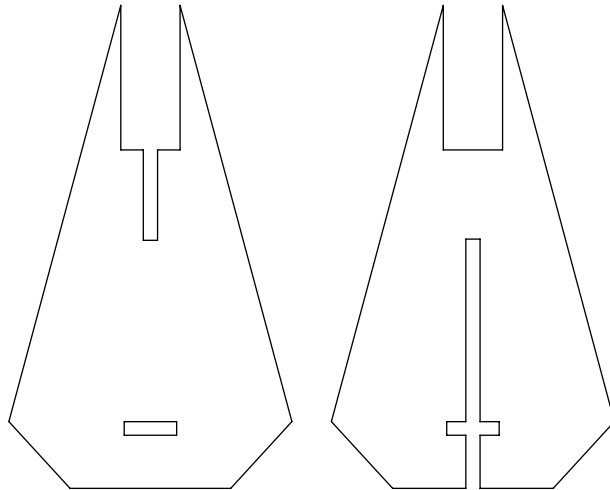

Candlestick



Leather Tab (2)



## SAFETY INFORMATION

---

Only suitable for direct mounting on non-combustible surfaces.  
Under no circumstances can Cross Fixtures be mounted on normally flammable surfaces.  
Suitable for dry, indoor use only.  
Maximum ambient temperatures: 25° C

## CROSS ASSEMBLY

1. Vertically slide piece A onto piece B where cut-outs are aligned.

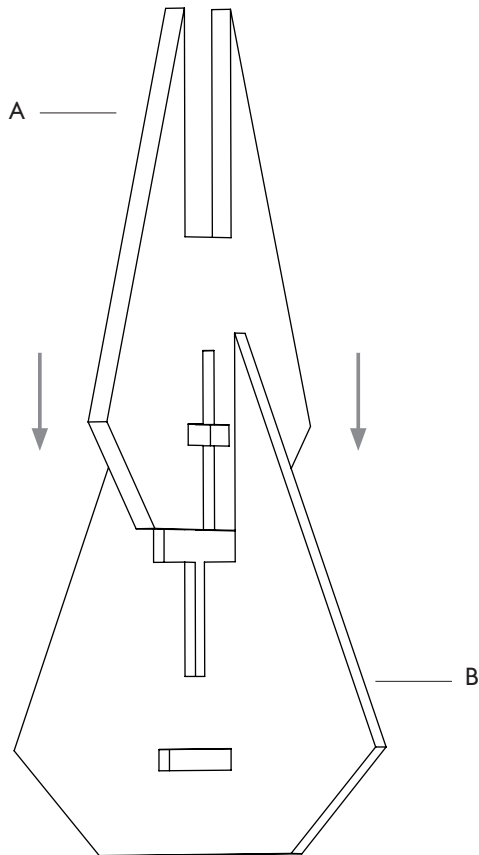

2. To secure together, slide leather tabs C and D through cut-out, one on top of the other.

3. Place provided candle into opening.

