

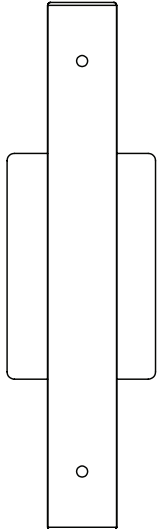

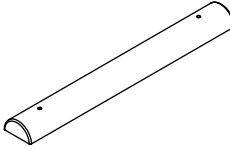

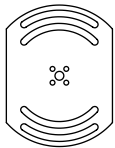

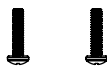

CONTENTS

Counterweight Rectangle Sconce 		Glass Shade 	Custom Crossbar 
		8-32 Thumb screws (2) 	8-32 Long screws (2) 
		8-32 Crossbar Screws (2) 	Wire connectors (7) 
(x4) Toggle anchor (240V only) 	(x4) Metal screw (240V only) 	Driver Box (240V only) 	
(x4) Wood screw (240V only) 	(x4) Long 8-32 screw (240V only) 		

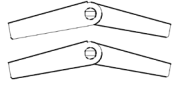
SAFETY INFORMATION

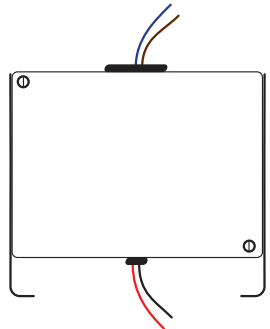
Only suitable for direct mounting on non-combustible surfaces.
 Under no circumstances can Counterweight Fixtures be mounted on normally flammable surfaces.
 Suitable for dry, indoor use only.
 Maximum ambient temperatures: 25° C

COUNTERWEIGHT SCONCE INSTALLATION (120V)

Note: Please contact a licensed electrician.

1. Connect the lead wires from J-box (A) to LED driver (B), with the provided 2-port wagos (C).
2. Pull the low voltage wires from the fixture (D), through the center hole of the custom crossbar (E). Then connect the low voltage wires to LED driver with the provided 2-port wagos (F).
3. Attach the custom crossbar (E) to J-box (A) with the provided two 8-32 screws (G).
4. Be sure to tuck all the wires into J-box, and not to pinch any wires.
5. Secure the fixture (D) to the custom crossbar (E) with the provided two 8-32 long screws (H).

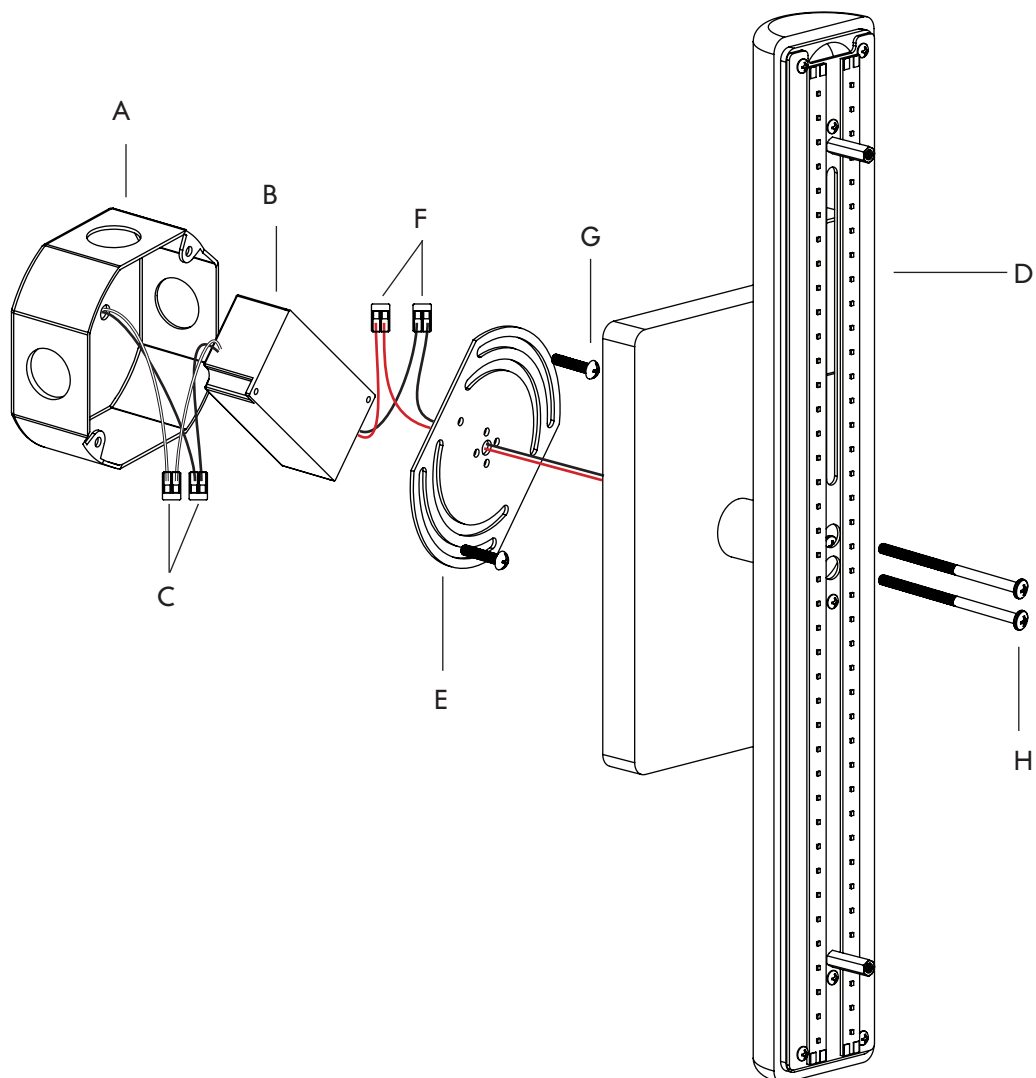

COUNTERWEIGHT SCONCE INSTALLATION (240V)

Note: Please contact a licensed electrician.

1. Connect the lead wires from 240V driver enclosure (A) with the provided 2-port wagos (B).
Then Connect the ground wire with provided 2-port wago (C).
2. Pull the low voltage wires from the fixture (D) through the center hole of the crossbar (E).
3. Connect the low voltage wires from the fixture to driver enclosure with the provided 2-port wagos (F).
4. Secure the custom crossbar (E) to the wall with the provided 8-32 screws or alternative 240V hardware (G).
5. Secure the fixture (D) to the custom crossbar (E) with the provided two 8-32 long screws (H).

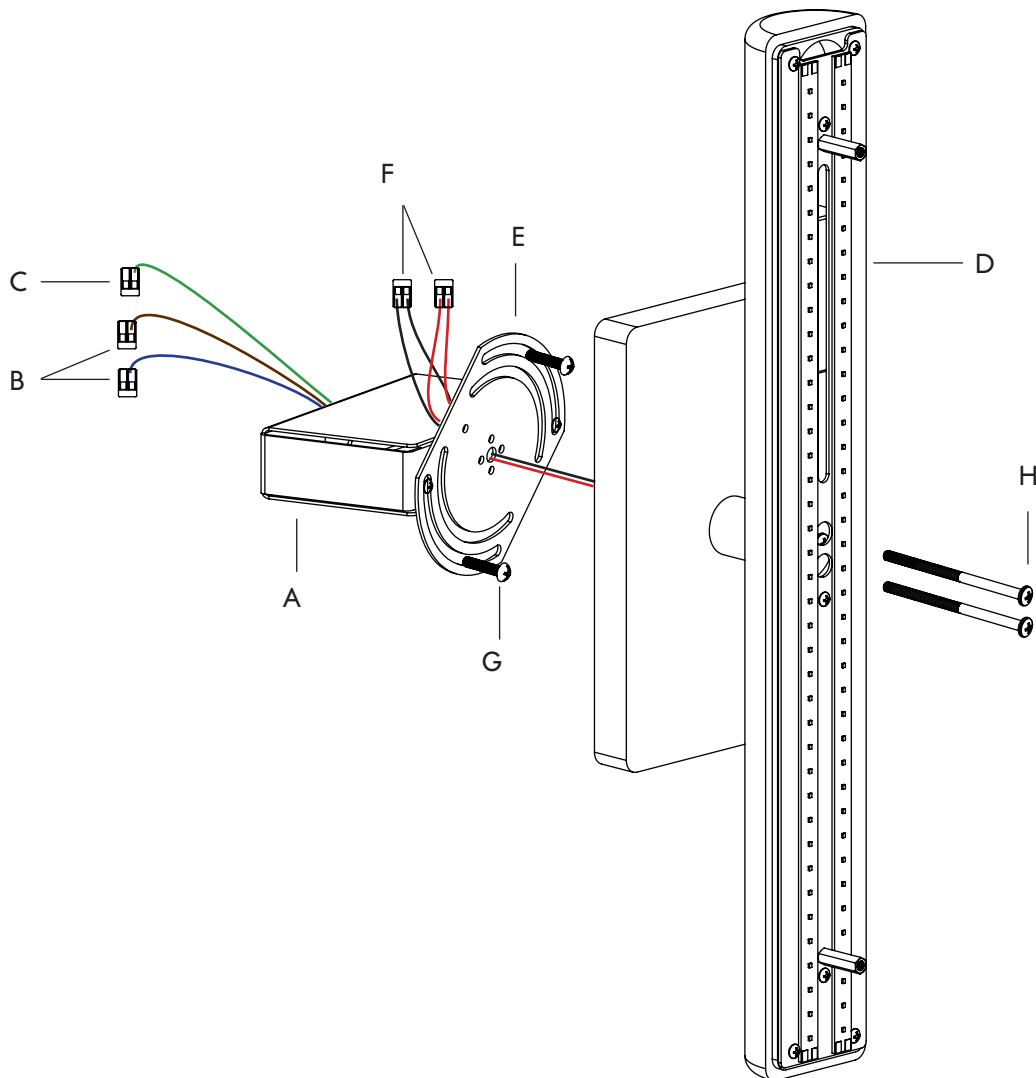

COUNTERWEIGHT SCONCE INSTALLATION

Glass Assembly

1. Position the holes of the glass (A) over the holes of the standoffs (B) on the fixture.
2. Fit the nylon washers (C) into the glass holes. Then screw the 8/32 thumb screws (D) until the glass is firmly pressed against the wood. Do not over tighten or the glass may break.

